

The Intralox logo is located in the top left corner of the image. It consists of the word "intralox" in a white, lowercase, sans-serif font, with a registered trademark symbol (®) to its upper right. Below the text is a white graphic element consisting of a horizontal line with several small circles and vertical bars, resembling a stylized conveyor belt or a molecular structure.

intralox®

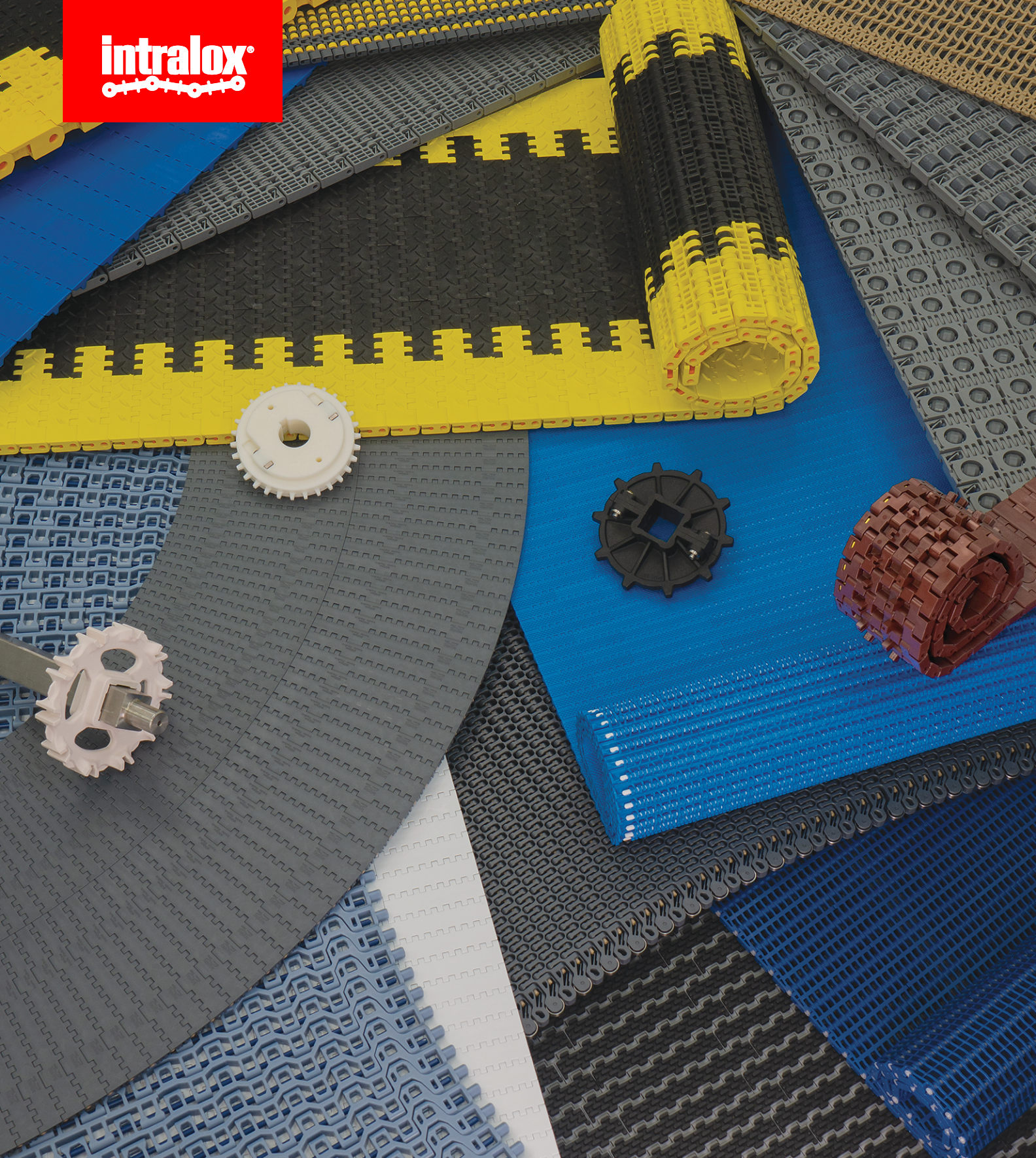

2021 INSTALLATION, MAINTENANCE & TROUBLESHOOTING MANUAL
MODULAR PLASTIC CONVEYOR BELTS

A subsidiary of Laitram, L.L.C. Intralox is a registered trademark of Laitram, L.L.C. All rights reserved worldwide. Intralox, L.L.C. manufactures products under one or more of the following U.S. patents: 5,072,640 - 5,074,406 - 5,083,660 - 5,101,966 - 5,156,262 - 5,156,264 - 5,316,522 - 5,361,893 - 5,372,248 - 5,377,819 - 5,507,383 - 5,544,740 - 5,597,063 - 5,598,916 - 5,850,902 - 5,904,241 - 6,119,848 - 6,138,819 - 6,148,990 - 6,209,714 - 6,209,716 - 6,334,528 - 6,367,616 - 6,398,015 - 6,401,904 - 6,439,378 - 6,467,610 - 6,474,464 - 6,494,312 - 6,499,587 - 6,554,129 - 6,571,937 - 6,644,466 - 6,681,922 - 6,695,135 - 6,705,460 - 6,749,059 - 6,758,323 - 6,811,021 - 6,837,367 - 6,926,134 - 6,968,941 - 6,997,306 - 7,055,678 - 7,070,043 - 7,111,725 - 7,147,099 - 7,191,894 - 7,210,573 - 7,216,759 - 7,228,954 - 7,237,670 - 7,249,669 - 7,249,671 - 7,248,653 - 7,311,192 - 7,344,018 - 7,360,641 - 7,393,451 - 7,424,948 - 7,426,992 - 7,461,739 - 7,494,006 - 7,506,750 - 7,506,751 - 7,533,776 - 7,537,104 - 7,537,106 - 7,540,368 - 7,575,113 - 7,588,137 - 7,607,533 - 7,617,923. Other U.S. and foreign patents pending.

Notice: The information contained in this manual is provided only as an aid and service to our customers.

Intralox, L.L.C. does not warrant that the design and/or operational function of any machine that incorporates and/or intends to incorporate Intralox, L.L.C. products, conforms to any local, state, or national regulations and standards relating to public safety, worker safety, safety guards, sanitation safety, fire safety, or any other safety regulations. ALL PURCHASERS AND USERS SHOULD CONSULT THEIR APPROPRIATE LOCAL, STATE, AND NATIONAL SAFETY REGULATIONS AND STANDARDS.

Intralox may make changes without notice to both this document and to products described by this document. Nothing in this document is intended to give rise to any obligation, contractual or otherwise, on the part of Intralox.

© Intralox, L.L.C. No part of this publication may be reproduced, transmitted, transcribed, stored in any retrieval system, or translated into any human or computer language by any means or in any form without prior written permission of Intralox.

The content of this document is proprietary to Intralox. Recipients may not disclose the content to anyone else without the written consent of Intralox and may only use the content in connection with Intralox products.

TABLE OF CONTENTS

Safety	7	Series 800-2	43
Safety Warnings.....	7	Belts Covered in Section.....	43
Equipment Installation Overview	9	Preformed Headed Rod.....	43
Overview.....	9	Splicing New Open Hinge Flush Edge (A) with Old Flush Edge (B).....	44
Shaft Installation.....	9	Series 800-3	47
Sprocket Installation.....	9	Belts Covered in Section.....	47
Wearstrip Installation.....	13	Unheaded Rod.....	47
Belt Installation.....	14	Series 800-4	49
Wide Belt Installation.....	17	Belts Covered in Section.....	49
Finger Transfer Plate Installation.....	17	Unheaded Rod.....	49
Dead Plate Installation.....	19	Series 800-5	51
Abrasion Resistant Rod Installation.....	21	Belts Covered in Section.....	51
Straight-Running Belts	23	Unheaded Rod.....	51
Series 100-1	25	Sprocket Spacers.....	51
Belts Covered in Section.....	25	Series 850-1	55
Preformed Headed Rod.....	25	Belts Covered in Section.....	55
Abrasion Resistant Rod.....	25	Preformed Headed Rod.....	55
Splicing New Belt with Original Belt.....	26	Series 888-1	57
Series 200-1	27	Belts Covered in Section.....	57
Belts Covered in Section.....	27	Check Belt Alignment.....	57
Thermally Formed Headed Rod.....	27	Unheaded Rod.....	57
Abrasion Resistant Rod.....	27	Medium Slot (without Stainless Steel Links) Sprocket Installation.....	58
Sprocket Installation & Direction of Rotation.....	28	Medium and Large Slot (with Stainless Steel Links) Sprocket Installation.....	58
Linking Belt Joints.....	28	Series 888-2	59
Series 400-1	29	Belts Covered in Section.....	59
Belts Covered in Section.....	29	Unheaded Rod.....	59
Preformed Headed Rod.....	29	Series 900-1	61
Unheaded Rod & Slidex Retainer.....	29	Belts Covered in Section.....	61
Abrasion Resistant Rod.....	30	Preformed Headed Rod.....	61
Splicing Flush and Original Edges.....	31	Abrasion Resistant Rod.....	62
Series 400-2	33	Friction Top Belt Returnway Requirements.....	62
Belts Covered in Section.....	33	Mold to Width (MTW) Sprocket Position.....	62
Thermally Formed Headed Rod.....	33	Series 900-2	63
Series 400-3	35	Belts Covered in Section.....	63
Belts Covered in Section.....	35	Nylon Rod Overview.....	63
Unheaded Rod.....	35	Unheaded Rod.....	63
Series 550-1	37	Locked Sprocket Location.....	65
Belts Covered in Section.....	37	Series 1000-1	69
Unheaded Rod.....	37	Belts Covered in Section.....	69
Series 560-1	39	Unheaded Rod.....	69
Belts Covered in Section.....	39	Series 1000-2	71
Unheaded Rod.....	39	Belts Covered in Section.....	71
Series 800-1	41	Preformed Headed Rod.....	71
Belts Covered in Section.....	41		
Preformed Headed Rod.....	41		
Abrasion Resistant Rod.....	41		

TABLE OF CONTENTS

Series 1100-1	73	Series 1900-1	109
Belts Covered in Section.....	73	Belts Covered in Section.....	109
Unheaded Rod.....	73	Unheaded Rod & Shuttleplug Retainer.....	109
Splicing Original Edge (Version 1) with New Edge (Version 3)	74	Locked Sprocket Location.....	110
Splicing Old Edge (Version 2) with New Edge (Version 3)....	74	Series 4400-1	111
Series 1100-2	75	Belts Covered in Section.....	111
Belts Covered in Section.....	75	Overview.....	111
Unheaded Rod.....	75	Unheaded Rod.....	111
Splicing Original Edge (Version 1) with New Edge (Version 3)	76	Series 4500-1	113
Splicing Old Edge (Version 2) with New Edge (Version 3)....	76	Belts Covered in Section.....	113
Series 1200-1	79	Unheaded Rod.....	113
Belts Covered in Section.....	79	Belt Handling.....	114
Belt Run Direction.....	79	Series 4550-1	115
Unheaded Rod and Slidelox Retainer.....	79	Belts Covered in Section.....	115
Locked Sprocket Location.....	80	Unheaded Rod.....	115
Series 1400-1	83	Belt Handling.....	116
Belts Covered in Section.....	83	Series 7000-1	117
Unheaded Rod and Slidelox Retainer.....	83	Belts Covered in Section.....	117
MTW Sprocket Position.....	84	Unheaded Rod.....	117
Locked Sprocket Location.....	85	Series 7050-1	119
Series 1500-1	87	Belts Covered in Section.....	119
Belts Covered in Section.....	87	Unheaded Rod.....	119
Belt Run Direction.....	87	Belt Handling.....	119
Unheaded Rod.....	87	Series 9000-1	121
Splicing Contained Edge Belt to Original Belt.....	88	Belts Covered in Section.....	121
Locked Sprocket Location.....	88	Unheaded Rod.....	121
Series 1600-1	95	Splicing Original Design with Updated Design.....	122
Belts Covered in Section.....	95	Splicing Wide Belts.....	123
Unheaded Rod.....	95	Series 10000-1	125
Series 1650-1	97	Belts Covered in Section.....	125
Belts Covered in Section.....	97	Unheaded Rod and Slidelox Retainer.....	125
Preformed Headed Rod.....	97	Series 10000-2	127
Series 1700-1	99	Belts Covered in Section.....	127
Belts Covered in Section.....	99	Unheaded Rod and Slidelox Retainer.....	127
Unheaded Rod & Slidelox Retainer.....	99	100 mm MTW Sprocket Offset.....	128
Series 1700-2	101	200 mm MTW Sprocket Offset.....	128
Belts Covered in Section.....	101	Radius Belts	129
Overview.....	101	Series 2100-1	131
Unheaded Rod.....	101	Belts Covered in Section.....	131
Check Conveyor.....	102	Unheaded Rod.....	131
Series 1750-1	103	Series 2200-1	133
Belts Covered in Section.....	103	Belts Covered in Section.....	133
Unheaded Rod & Slidelox Retainer.....	103	Belt Installation.....	133
Series 1800-1	105	Unheaded Rod.....	133
Belts Covered in Section.....	105	S2200 with Insert Rollers.....	134
Unheaded Rod.....	105	Series 2200-2	135
Series 1800-2	107	Belts Covered in Section.....	135
Belts Covered in Section.....	107	Belt Run Direction.....	135
Unheaded Rod and Slidelox Retainer.....	107	Unheaded Rod.....	135
		Series 2300-1	137
		Belts Covered in Section.....	137
		Unheaded Rod.....	137

TABLE OF CONTENTS



Series 2400-1	139	Troubleshooting	175
Belts Covered in Section.....	139	Straight-Running Belts.....	175
Belt Installation.....	139	Radius Belts.....	179
Unheaded Rods.....	139	INDEX	181
Splicing New Flush Edge (A) with Old Flush Edge (B).....	140		
S2400 with Insert Rollers.....	141		
Series 2400-2	143		
Belts Covered in Section.....	143		
Belt Run Direction.....	143		
Unheaded Rod.....	143		
Series 3000-1	145		
Belts Covered in Section.....	145		
Steel Pin.....	145		
Section Replacement.....	145		
Series 4000-1	147		
Belts Covered in Section.....	147		
Steel Pin.....	147		
Section Replacement.....	147		
Spiral Belts	149		
Series 2600-1	151		
Belts Covered in Section.....	151		
Unheaded Rod.....	151		
S2600 Outer Edge & Dual Turning 2.0.....	152		
Spiral Sprocket Installation.....	153		
Spiral Travel Direction.....	154		
Series 2700-1	155		
Belts Covered in Section.....	155		
Unheaded Rod.....	155		
S2700 2.2/2.7 Radius with Occluded Holes on the Flush Edge.....	156		
Spiral Sprocket Installation.....	157		
Series 2800-1	159		
Belts Covered in Section.....	159		
Unheaded Rod.....	159		
Spiral Sprocket Installation.....	159		
Series 2850-1	163		
Belts Covered in Section.....	163		
Unheaded Rod.....	163		
Series 2900-1	165		
Belts Covered in Section.....	165		
Unheaded Rod.....	165		
S2900 Spiral DirectDrive.....	165		
S2900 Spiral GTech 1.6 and 2.2.....	166		
Series 2950-1	169		
Belts Covered in Section.....	169		
Unheaded Rod.....	169		
Belting Storage Recommendations	171		
Storage Suggestions.....	171		
Storage Warnings.....	171		
Preventive Maintenance	173		

SAFETY

SAFETY WARNINGS

Review the following safety warnings before installing, removing, maintaining, or troubleshooting Intralox belts.

Certain belts have pinch points. For those belts, a safety warning is also embedded in the related section of these instructions. Complete information about this hazard is provided on a warning tag delivered with these belts.

Symbol	Message	Symbol	Message
	<p>WARNING This belt can trap and injure fingers. Never touch a moving belt! Stop the conveyor before servicing.</p>		<p>Keep hands and fingers clear of moving parts.</p>
	<p>Follow all appropriate lockout/tagout and safety procedures, and use appropriate PPE.</p>		

EQUIPMENT INSTALLATION OVERVIEW

OVERVIEW

Before installing an Intralox belt, the shafts, sprockets, and various other components must be installed.

SHAFT INSTALLATION

- Use the triangulation method to check shaft alignment and ensure the shafts are parallel even when the conveyor frame is not square.

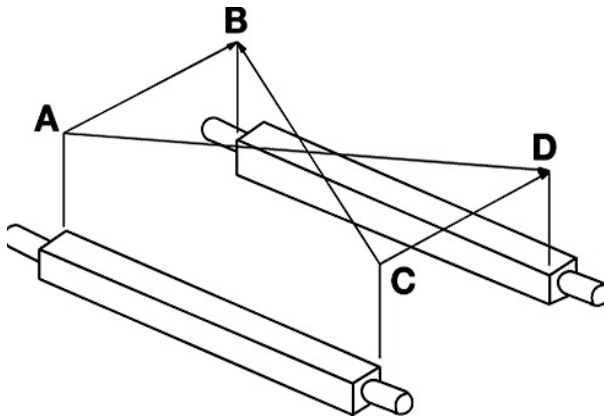

Figure 1: If **AD** and **BC** are equal, and **AB** and **CD** are equal, then the shafts are square with each other.

- Align the shafts in the same relative position for the entire length of the conveyor so the belt tracks properly.

SPROCKET INSTALLATION

SPROCKET ALIGNMENT

- Align sprocket teeth in the same position. Inspect by looking down the shaft.

- Ensure the pilot holes on all sprockets with an uneven number of teeth are aligned on the same side of the shaft.

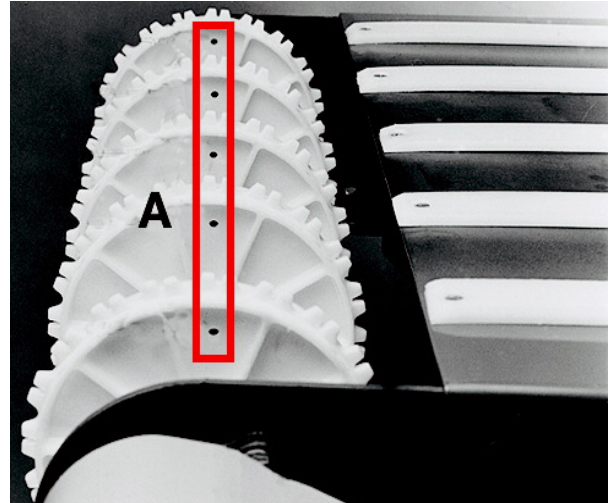

A Ensure pilot holes are aligned
Figure 2: Shaft with aligned sprockets

- When installing sprockets with a number of teeth unevenly divided by 4 on a square shaft, ensure the sprocket alignment notches are aligned on the same side of the shaft.

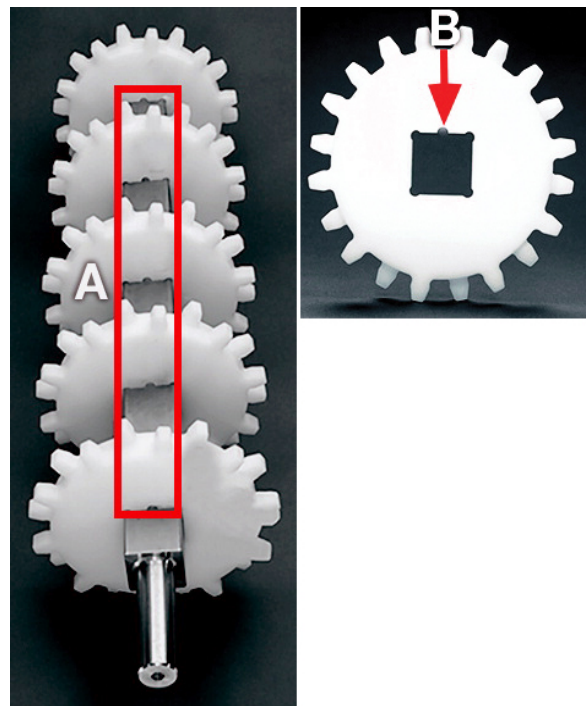

A Notches aligned
B Sprocket alignment notches

Figure 3: Ensure sprocket alignment notches are aligned

EQUIPMENT INSTALLATION OVERVIEW

SPROCKET POSITIONS ON THE SHAFT

NOTE: This information does not apply to Series 888, Series 2600, Series 2700, Series 2800, or Series 2900. See those specific sections on the following pages for more information.

- Lock one sprocket on each on the drive and idle shafts to maintain proper lateral tracking.

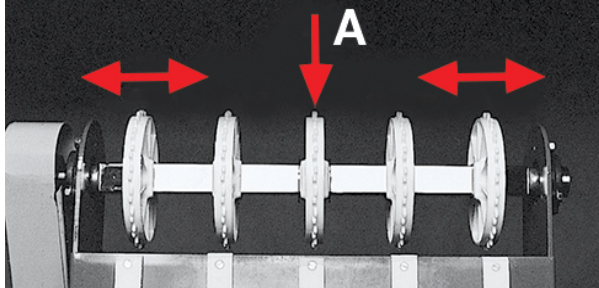

A Locked sprocket

Figure 4: Lock one sprocket each on drive and idle shafts

- Position the locked sprockets in the same location on each shaft.
- Ensure the non-locked sprockets on the shaft are free to move with the elongation and contraction of the belt.
- If there are only two sprockets per shaft, only lock the sprockets on the drive journal side.
- See the following table for center sprocket offset and maximum sprocket spacing information.

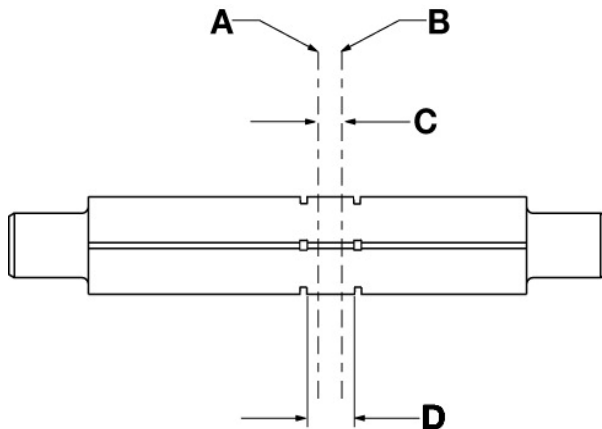

- A** Centerline of belt
- B** Centerline of sprocket
- C** Offset
- D** Sprocket width

Figure 5: Center sprocket offset and maximum sprocket spacing

Series	Number of Links	Center Sprocket Offset				Notes
		Offset		Max. Sprocket Spacing		
		in	mm	in	mm	
100	even	0	0	6	152	
	odd	0.12	3	6	152	
200	even, odd	0	0	7.5	191	
200 RR	even, odd	0.09	2.3	7.5	191	
400	even	0	0	6	152	
	odd	0.16	4	6	152	
400 RT, ARB, TRT						See Center Sprocket Offset for Roller Belts.
550	even	0	0	5	127	
	odd	0.5	12.7	5	127	
800	even, odd	0	0	6	152	
800 Angled EZ Clean	even, odd	0.16	4	6	152	6-, 10-, and 16-tooth sprockets can be placed on belt centerline.
800 RR	even	3	76	6	152	
	odd	0	0	6	152	
850	even, odd	0	0	6	152	
888						See Medium Slot (without Stainless Steel Links) Sprocket Installation and Medium and Large Slot (with Stainless Steel Links) Sprocket Installation or contact Intralox Customer Service.
900	even	0	0	4	102	
	odd	0.16	4	4	102	
900 OFG						For offset and number of links, see Locked Sprocket Location or contact Intralox Customer Service.
1000	even	0	0	6	152	
	odd	0.25	6.44	6	152	

EQUIPMENT INSTALLATION OVERVIEW

Center Sprocket Offset						
Series	Number of Links	Offset		Max. Sprocket Spacing		Notes
		in	mm	in	mm	
1000 insert roller, high density insert roller	even	1.5	38	6	152	
	odd	0	0	6	152	
1000 high density insert roller 85 mm	even	1.67	42.5	6	152	
	odd	0	0	6	152	
1100	even (whole)	0	0	4	102	The 8- and 12-tooth steel sprockets can be placed on belt centerline.
	odd (whole)	0.5	12.7	4	102	
	even, odd	0.25	6.35	4	102	Even or odd number of links in 0.5-in (12.7-mm) increments The 8- and 12-tooth steel sprockets can be placed on belt centerline.
1100 EZ tracking sprockets	even (whole)	0.19	4.8	4	102	
	odd (whole)	0.31	7.9	4	102	
	even, odd	0.06	1.52	4	102	Even or odd number of links in 0.5-in (12.7-mm) increments
1200				6	152	For offset and number of links, see Locked Sprocket Location or contact Intralox Customer Service.
1400	even	0	0	6	152	
	odd	0.5	12.7	6	152	
1400 FG				6	152	For offset and number of links, see Locked Sprocket Location or contact Intralox Customer Service.

Center Sprocket Offset						
Series	Number of Links	Offset		Max. Sprocket Spacing		Notes
		in	mm	in	mm	
1500				6	152	For offset and number of links, see Locked Sprocket Location or contact Intralox Customer Service.
1600	even, odd	0	0	4	102	
1650	even, odd	0.25	6.4	4	102	The 20-tooth sprocket has zero offset.
1700	even	0.5	12.7	4	102	
	odd	0	0	4	102	
1750	even	0	0	4	102	When determining number of links, drop the 0.5 link.
	odd	0.5	12.7			
1800	even, odd	0	0	6	152	
1900				3	76	For offset and number of links, see Locked Sprocket Location or contact Intralox Customer Service.
2100	even, odd	1.97	50	3.94	100	
2200	even	0.25	6.4	4	102	When determining number of links, drop the 0.5 link. Offset to left of shaft centerline looking in the direction of the preferred belt run direction.
	odd	0.25	6.4	4	102	When determining number of links, drop the 0.5 link. Offset to right of shaft centerline looking in the direction of the preferred belt run direction.
2300	even	0	0	6	152	
	odd	1.5	38	6	152	

EQUIPMENT INSTALLATION OVERVIEW

Center Sprocket Offset						
Series	Number of Links	Offset		Max. Sprocket Spacing		Notes
		in	mm	in	mm	
2400	even	0.125	3.2	6	152	When determining number of links, drop the 0.5 link. Offset to left of shaft centerline looking in the direction of the preferred belt run direction.
	odd	0.125	3.2	6	152	When determining number of links, drop the 0.5 link. Offset to right of shaft centerline looking in the direction of the preferred belt run direction.
2600	even, odd	0	0	8	203	
2700	even, odd	0	0	8	203	
2800	even	0	0	6	152	
	odd	0.5	12.7	6	152	
4400	even, odd	0.5	12.7	9	229	
4500	even	0.5	12.7	6	152	
	odd	0	0	6	152	
4500 dual tooth sprockets	even	0	0	6	152	
	odd	0.5	12.7	6	152	
9000	even	0.5	12.7	4	102	
	odd	0	0	4	102	
10000 hinge drive (preferred)	even	0.25	6.3	5.91	150	Offset to left of shaft centerline looking in the direction of the preferred belt run direction.
	odd	0.25	6.3	5.91	150	Offset to right of shaft centerline looking in the direction of the preferred belt run direction.

Center Sprocket Offset						
Series	Number of Links	Offset		Max. Sprocket Spacing		Notes
		in	mm	in	mm	
10000 center drive	even	0.25	6.3	5.91	150	Offset to right of shaft centerline looking in the direction of the preferred belt run direction.
	odd	0.25	6.3	5.91	150	Offset to left of shaft centerline looking in the direction of the preferred belt run direction.
	Number of rollers per row					
400 RT, Angled Roller, TRT	even	0	0	6	152	
	odd	1	25.4	6	152	

Center Sprocket Offset for Roller Belts						
Series	Number of Rollers	Offset		Max. Sprocket Spacing		Notes
		in	mm	in	mm	
400	even	0	0	6	152	
	odd	1	25.4	6	152	
4500	even	0	0	6	152	
	odd	1	25.4	6	152	
4550	even	0	0	6	152	
	odd	1	25.4	6	152	
7000	Divisible by 4	1	25.4	6	152	Number of rollers = belt width in inches - 1 (belt width in mm/25.4 - 1)
	Not divisible by 4	0	0	6	152	
7050	Divisible by 8	1	25.4	6	152	
	Not divisible by 8	0	0	6	152	

SPLIT SPROCKET TORQUE SPECIFICATIONS

Ensure split sprockets are tightened to the following specifications: 8.3-10.4 lb ft (11.3-14.1 Nm).

WEARSTRIP INSTALLATION

Plastic wearstrip installation should allow for thermal expansion and contraction.

FLAT FINGER-JOINT WEARSTRIPS

- Starting at the idle end of the conveyor, cut the tongues from the first wearstrips and bevel the leading edges.
- Place the wearstrips in position.
- Drill a 0.25 in (6 mm) hole in the wearstrip and frame.

NOTE: Before mounting, ensure there is proper clearance between the tongues and grooves. Ensure all tongues point in toward the idle shaft.

- Using the plastic bolt and nut, fasten the wearstrips to the frame.
- Continue this process, working toward the drive end of the conveyor.
- Cut off the excess wearstrips at the drive end and fasten the wearstrips to the frame.

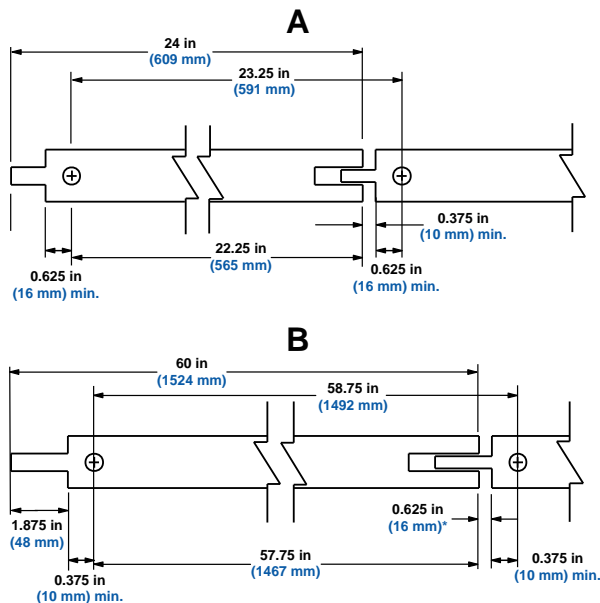

- A Idle end
- B Drive end
- * Minimum

Figure 6: Flat Finger-Joint Wearstrips

FLAT AND ANGLE WEARSTRIPS

- Bevel cut the opposing ends of the wearstrips.
 - A 30-degree angle with the horizontal and a 0.30 in (8 mm) clearance gap usually works best.

- In extreme conditions, a 60-degree angle is needed. The clearance must be determined by thermal expansion calculations.

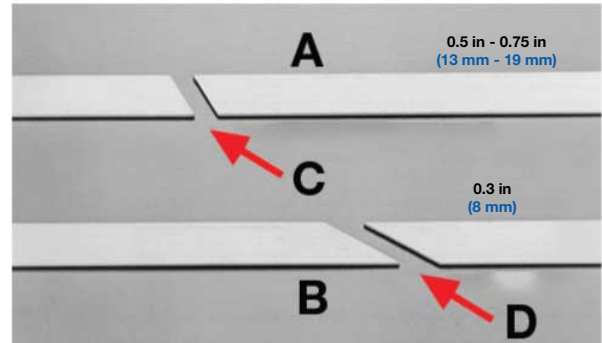

- A Operating temp. of 100°F (37°C) or more
- B Operating temp. of 100°F (37°C) or less
- C 60.00 degrees
- D 30.00 degrees

Figure 7: Bevel cut opposing wearstrip ends

- Place the wearstrips in position and stagger the wearstrip joint locations for smooth belt operation.
- Drill a 0.25 in (6 mm) hole in the wearstrips and frame at the idle end of the conveyor.
- Using the plastic bolt and nut, fasten the wearstrips to the frame.
- Drill slotted holes through the wearstrips and frame every 2 ft (0.61 m) to 5 ft (1.52 m) on centerlines, working toward the drive end of the conveyor.
- Cut off the excess wearstrips at the drive end and fasten the wearstrips to the frame.

EQUIPMENT INSTALLATION OVERVIEW

BELT INSTALLATION

PREPARATION

The following procedures are basic instructions for installing Intralox belting. Not all conveyors are alike. Each conveyor frame and each application may have special considerations. Review the following information before installing or replacing a belt.

- In most retrofits, Intralox belting can run directly on the same carryways as the replaced belt.
- Ensure carryways are clean, in good condition, not grooved from belt wear, and free of debris.
- Ensure the existing wearstrip material is compatible with the new belt.
- Replace damaged, worn, or incompatible wearstrips as needed.

TOP & BOTTOM INSPECTION

If belt geometry is not symmetrical on top and bottom, a dedicated top (product conveyance surface) and bottom (sprocket driving surface) must be determined before installation. Some distinguishing features on open area belts are:

- The bottom side has geometry designed for the sprocket tooth to engage (drive bar, drive pockets).
- The top side has a closed hinge and the bottom side has an open hinge design.
- Center bars/spines are wider on the top side than the bottom side.
- The end of the rod is usually more exposed on the bottom side.

If still unclear, refer to the belt drawing for the specific series and style in the Intralox Modular Plastic Conveyor Belts Engineering Manual.

STANDARD BELT INSTALLATION

1. If there is a shaft take-up, move the adjustment to the relaxed or loose-belt position.
2. Feed the belt down the carryway from the conveyor drive end.



Figure 8: Feed belt from drive end

3. Center the belt on the conveyor frame, noting the location of the locked sprocket.
4. Ensure there is space between the belt edges and the conveyor frame to accommodate belt expansion.

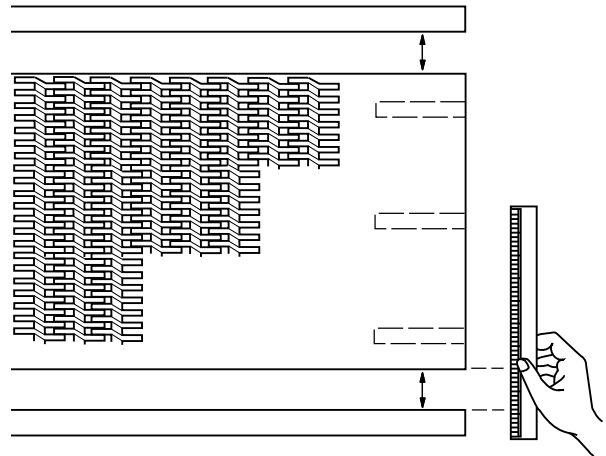

Figure 9: Measure distance between belt edge and frame

EQUIPMENT INSTALLATION OVERVIEW

5. Wrap the belt around the idle sprockets, ensuring the sprockets remain aligned and in position. The two outboard sprockets must engage the belt 1.5 in (38 mm) to 2 in (51 mm) in from the outer belt edges.

NOTE: For Series 1100, the two outboard sprockets must engage 1 in (25.4 mm) in from the outer belt edges.

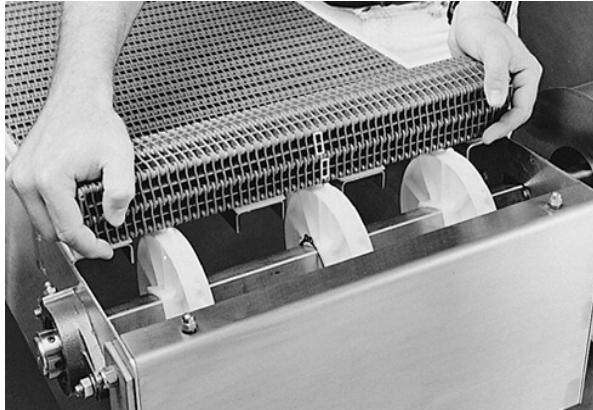

Figure 10: Wrap belt around idle sprockets

6. Once wrapped around the idle sprockets, feed the belt down the returnway until it reaches the drive sprockets.

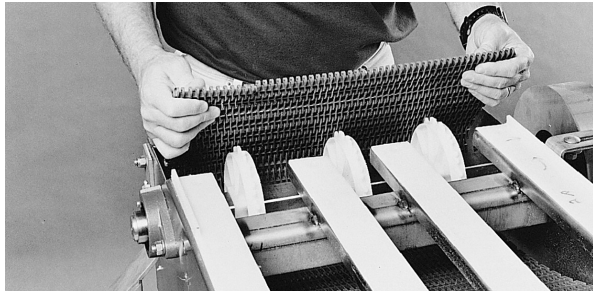

Figure 11: Feed belt down returnway

7. Wrap the belt around the drive sprockets, keeping the drive end and idle end locked sprockets in the same lateral position.

NOTE: Ensure the belt engages the drive and idle end locked sprocket in the same position. Failure to do this causes belt mistracking.

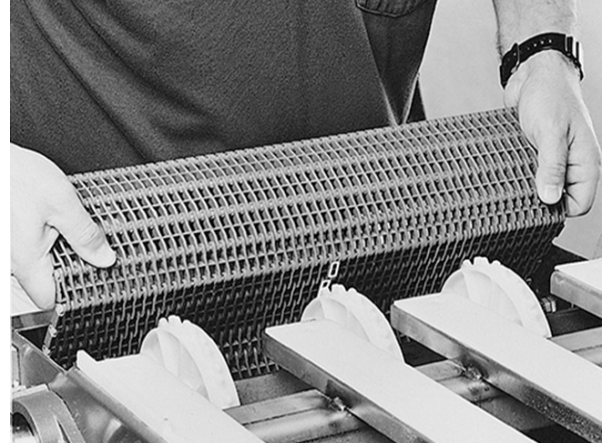

Figure 12: Wrap belt around drive sprockets

8. Push the belt ends together to engage the links and ensure the edges are properly aligned.

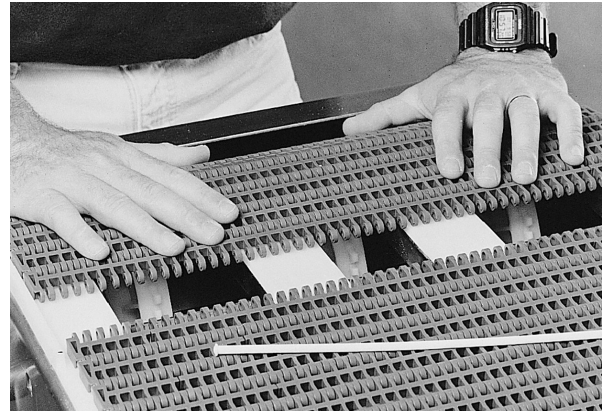

Figure 13: Push belt ends together

9. Clip the rod at an angle to make insertion easier.



Figure 14: Clip rod at angle

EQUIPMENT INSTALLATION OVERVIEW

- After any final adjustments, insert a rod to join the belt ends (see specific instructions for your belt series and style).



Figure 15: Insert rod

CHECKING THE INSTALLATION

- Jog the conveyor slowly or manually push the belt forward so the drive shaft revolves several times.
- While the belt moves, ensure the drive and idle shaft sprockets fully engage the belt and the belt tracks properly.



Keep hands and fingers clear of moving parts.

- If the sprockets engage the belt properly and the belt tracks properly, ensure the shaft bearings and conveyor frame are aligned properly.
 - If the belt and sprockets do not engage, repeat the [Sprocket Installation](#) and [Belt Installation](#) procedures in this section.
 - If the belt does not track properly, check the sprocket positions on both shafts. See [Sprocket Installation](#) in this section.

CATENARY SAG

- If needed, add or remove belt rows or adjust the take-up to achieve proper catenary sag for belt tension.

NOTE: For additional information regarding the calculation of proper catenary sag, see the Design Guidelines in the [Intralox Conveyor Belting Engineering Manual](#).

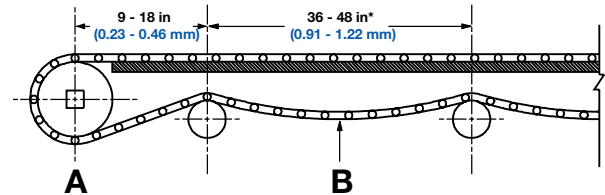

A Drive sprocket

B Catenary sag: set up at 1 in (25.4 mm) to 6 in (152 mm) during operational temperature

* For all except Series 100, Series 400, and Series 1200. These series should have rollers spaced from 48 in (1219 mm) to 60 in (1524 mm)

Figure 16: Proper catenary sag

Roller Diameter	
Belt Pitch	Minimum Roller Diameter
0.6 in, 1.0 in	2 in (51 mm)
1.25 in, 1.5 in, 2.0 in, 2.5 in	4 in (102 mm)

- Once the belt is properly tensioned and running smoothly, secure the rod in place. (See specific instructions for your belt series and style.)

BREAK-IN PERIOD

The break-in period usually occurs during the first several days of operation. Depending on the application and environment, belts elongate from 0.5% to 1% of their total length during the break-in period.

If belt elongation is excessive, remove one or more rows of modules to maintain proper catenary sag and belt tension.

WIDE BELT INSTALLATION

Installing belting on wide conveyors is more difficult than on narrow conveyors. Using the conveyor motor to pull the belt may ease installation.

NOTE: If needed, belt pullers can be purchased from Intralox. Contact Intralox Customer Service for more information.

1. Place supports across the width of the belt between the shoes or rollers to prevent the belt from forming catenary sags before the belt ends are joined.



Figure 17: Place supports across width of belt

2. Starting at the idle end, slide the belt over the carryway.
3. Wrap the belt around the drive sprockets.
4. Once wrapped around the drive sprockets, use the motor, if possible, to pull the belt down the carryway.
5. While pulling the belt down the carryway, feed the belt manually through the returnway and continue adding sections of belt.
6. When the belt in the returnway reaches the idle end of the conveyor, pull it up and wrap it around the idle sprockets. Pull up enough belt to prevent it from slipping back.
7. Lock the idle shaft in place to prevent the belt from moving.
8. When the belt is the proper length and the belt ends are close, align the hinges.
9. Insert a rod to join the belt ends (see specific instructions for your belt series and style).
10. Once the belt is joined, reverse the motor running direction and pull the belt tight.
11. Return the motor to the normal running direction.
12. Adjust the take-up (if provided) and add or remove belt rows to achieve proper catenary sag.
13. Remove the supports added in step 1.

14. After any final adjustments, secure the rod in place (see specific instructions for your belt style).
15. Once the belt is closed, run the conveyor to ensure the belt tracks properly.

FINGER TRANSFER PLATE INSTALLATION

Proper finger transfer plate installation is required for trouble-free operation. Proper installation is especially critical for installations with high temperature variations, which cause significant thermal expansion of belts.

Finger transfer plates are manufactured with slots for Intralox plastic shoulder bolts.

NOTE: Intralox finger transfer plates work in conjunction with Raised Rib belts.

- Install finger transfer plates using only Intralox plastic bolts in the plate slots.

NOTE: ONLY use Intralox plastic shoulder bolts. Any other shoulder bolts may damage equipment.

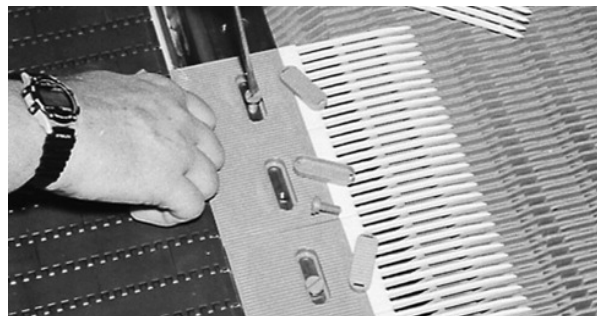

Figure 18: Install finger transfer plates using Intralox plastic bolts

- Do not attempt to over tighten plates. The loose fitting allows lateral movement of plates, which is required for belt expansion and contraction.

NOTE: Finger transfer plate slots allow limited expansion. If the installation involves wide belts with large temperature variations, contact Intralox Customer Service.

- For an even number of finger transfer plates, locate from the centerline of the belt. Straddle the centerline for an odd number of plates. The finger transfer plate must be level with the belt +0.03 in (0.8 mm), -0.00 with hinge rod at top dead center.

EQUIPMENT INSTALLATION OVERVIEW

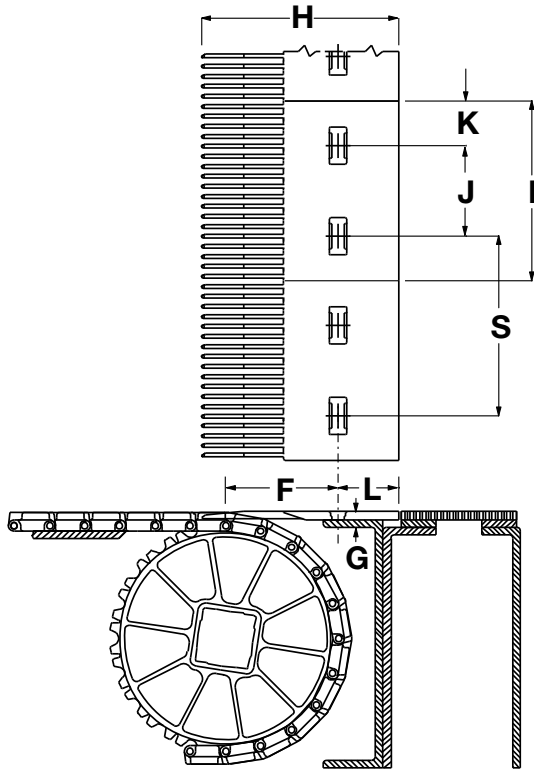

Figure 19: Finger transfer plates location

Dimensional Requirements for Finger Transfer Plate Installation																		
	Two-Material																	
	Standard												Glass-Handling					
	S100 & S2400		S400		S1200		S900				S1900		S400		S1200		S1900	
							6 in (152 mm)		4 in (102 mm) Retrofit									
in	mm	in	mm	in	mm	in	mm	in	mm	in	mm	in	mm	in	mm	in	mm	
F	2.38	61	3.50	89	3.50	89	3.50	89	2.38	61	3.50	89	3.50	89	3.50	89	3.50	89
G	0.19	5	0.31	8	0.31	8	0.25	6	0.19	5	0.31	8	0.31	8	0.31	8	0.31	8
H	5.83	148	7.25	184	7.25	184	6.50	165	5.83	148	6.11	155	8.26	210	8.26	210	6.11	155
I	3.96	101	5.91	150	5.91	150	5.92	150	3.94	100	5.91	150	5.91	150	5.91	150	5.91	150
J	2.50	64	3.00	76	3.00	76	3.00	76	2.18	55	3.00	76	3.00	76	3.00	76	3.00	76
K	0.74	19	1.45	37	1.45	37	1.45	37	0.90	23	1.45	37	1.45	37	1.45	37	1.45	37
L	2.00	51	2.00	51	2.00	51	2.00	51	2.00	51	5.50	140	5.50	140	5.50	140	5.50	140
	Spacing at Ambient Temperatures																	
S	PP 3.979 (101.1)		PP 5.952 (151.2)		Composite PP 6.000 (152.4)		PP	AC	AC 3.976 (101.0)		Enduralox™ PP 6.000 (152.4)		PP 5.952 (151.2)		Composite PP 6.000 (152.4)		Enduralox PP 6.000 (152.4)	
	AC 3.976 (101.0)		PE 5.933 (150.7)				5.981 (151.9)	5.975 (151.8)					PE 5.933 (150.7)					

DEAD PLATE INSTALLATION

DEAD PLATES WITH GAP

1. For proper dead plate installation, position the belt so a rod is directly above the centerline of the shaft.
2. Mount the dead plate using the minimum gap shown in the following tables. The minimum gap prevents contact between the belt and the dead plate during operation.

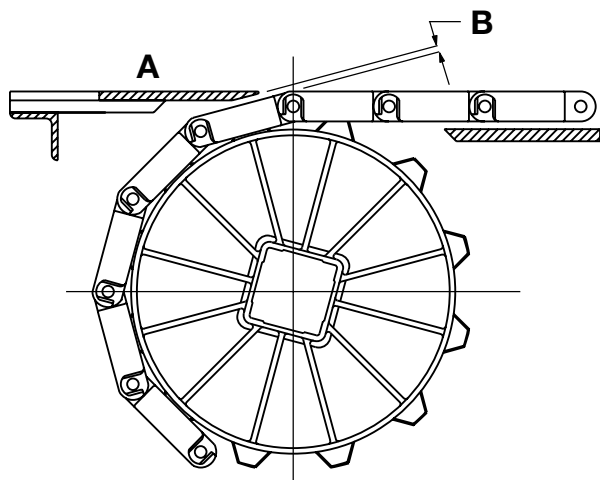

A Dead plate top surface; typically 0.031 in (0.8 mm) above the belt surface for product transfer onto the belt and 0.031 in (0.8 mm) below the belt for product transfer off the belt.

B Dead plate gap

Figure 20: Mount dead plate using minimum gap

Dead Plate Gap				
Sprocket Description			Gap	
Pitch Diameter		No. of Teeth	in	mm
in	mm			
Series 100				
2.0	51	6	0.134	3.4
3.5	89	11	0.073	1.9
6.1	155	19	0.041	1.0
Series 200				
4.0	102	6	0.268	6.8
6.4	163	10	0.160	4.1
10.1	257	16	0.100	2.5
Series 400				
4.0	102	6	0.268	6.8
5.2	132	8	0.200	5.1

Dead Plate Gap				
Sprocket Description			Gap	
Pitch Diameter		No. of Teeth	in	mm
in	mm			
5.8	147	9 (Flush Grid acetal)	0.178	4.5
6.4	163	10	0.160	4.1
7.8	198	12	0.130	3.3
8.4	213	13 (Flush Grid acetal)	0.121	3.1
10.1	257	16	0.100	2.5
Series 550				
2.4	61	24	0.028	0.7
3.2	81	32	0.021	0.5
Series 800				
4.0	102	6	0.268	6.8
5.2	132	8	0.200	5.1
6.5	165	10	0.158	4.0
7.7	196	12	0.132	3.4
10.3	262	16	0.098	2.5
Series 850				
4.0	102	6	0.268	6.8
5.2	132	8	0.200	5.1
6.5	165	10	0.158	4.0
7.7	196	12	0.132	3.4
10.3	262	16	0.098	2.5
Series 900				
2.1	53	6	0.147	3.7
3.1	79	8	0.095	2.4
3.5	89	10	0.084	2.1
4.1	104	12	0.071	1.8
5.1	130	15	0.057	1.4
5.8	147	17	0.050	1.3
6.1	155	18	0.047	1.2
6.8	173	20	0.042	1.1
9.8	249	28	0.029	0.7
Series 1000				
3.1	79	16	0.029	0.7
4.6	117	24	0.020	0.5
6.1	155	32	0.015	0.4
Series 1100				
1.6	41	8	0.058	1.5

EQUIPMENT INSTALLATION OVERVIEW

Dead Plate Gap				
Sprocket Description			Gap	
Pitch Diameter		No. of Teeth	in	mm
in	mm			
2.3	58	12	0.040	1.0
3.1	79	16	0.029	0.7
3.5	89	18	0.026	0.7
3.8	97	20	0.024	0.6
4.6	117	24	0.020	0.5
5.1	130	26	0.018	0.4
6.1	155	32	0.015	0.4
Series 1200				
6.5	165	14	0.081	2.1
7.9	201	17	0.067	1.7
10.2	259	22	0.052	1.3
Series 1400				
3.9	99	12	0.066	1.7
5.1	130	16	0.050	1.3
5.7	145	18	0.044	1.1
6.7	170	21	0.038	1.0
Series 1500				
2.3	58	14	0.028	0.7
2.7	69	17	0.023	0.6
3.8	97	24	0.017	0.4
5.7	145	36	0.011	0.3
Series 1600				
2.0	51	6	0.134	3.4
3.2	81	10	0.079	2.0
3.9	99	12	0.066	1.7
6.4	163	20	0.039	1.0
Series 1650				
2.0	51	6	0.134	3.4
3.2	81	10	0.079	2.0
3.9	99	12	0.066	1.7
6.4	163	20	0.039	1.0
Series 1700				
5.8	147	12	0.224	5.7
6.7	170	14	0.210	5.3
7.7	196	16	0.199	5.0
Series 1800				
5.0	127	6	0.150	3.8
6.5	165	8	0.108	2.8

Dead Plate Gap				
Sprocket Description			Gap	
Pitch Diameter		No. of Teeth	in	mm
in	mm			
8.1	206	10	0.091	2.3
10.5	267	13	0.074	1.9
Series 1900				
6.7	170	10	0.164	4.2
10.6	269	16	0.102	2.6
Series 2200				
3.9	99	8	0.150	3.6
5.3	135	11	0.108	2.8
6.3	160	13	0.091	2.3
7.7	196	16	0.074	1.9
Series 2400				
2.0	51	6	0.134	3.4
3.9	99	12	0.065	1.7
5.1	130	16	0.050	1.3
6.4	163	20	0.039	1.0
Series 2600 & 2700 spiral				
5.2	132	8	0.200	5.1
6.5	165	10	0.158	4.0
Series 2800 spiral				
6.3	160	13	0.091	2.3
Series 3000				
5.2	132	8	0.200	5.1
6.5	165	10	0.158	4.0
7.7	196	12	0.132	3.4
Series 4000				
3.9	99	12	0.066	1.7
5.1	130	16	0.050	1.3
5.7	145	18	0.044	1.1
6.7	170	21	0.038	1.0
Series 7000				
8.3	211	8	0.318	8.1
10.3	262	10	0.253	6.4
Series 9000				
6.5	164	20	0.040	1.0
8.1	205	25	0.032	0.8

DEAD PLATES WITHOUT GAP

In some installations, the tip of the dead plate may need to contact the belt rather than maintain a gap. To do this, hinge the dead plate support so the dead plate moves as the belt passes.

NOTE: There is a small oscillating motion that may cause tipping for sensitive product containers.

ABRASION RESISTANT ROD INSTALLATION

The Intralox abrasion resistant rods enhance the performance of Intralox belts in abrasive or gritty environments. These rods are held in place on both ends by short rods made of abrasion resistant plastic with preformed heads called rodlets.

See specific series sections for instructions regarding abrasion resistant rod installation.

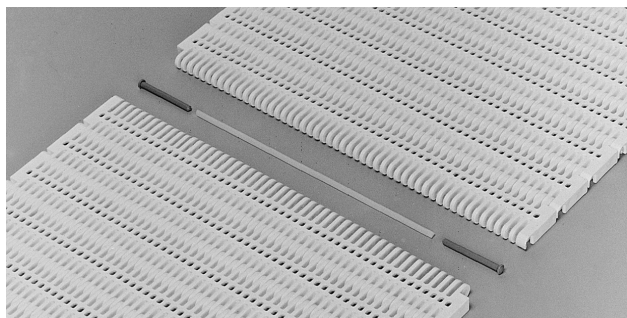

Figure 21: Abrasion resistant rod and rodlets

STRAIGHT-RUNNING BELTS

SERIES 100-1

BELTS COVERED IN SECTION

- Flush Grid
- Raised Rib

NOTE: Before use in food-safe applications, follow good manufacturing practice and thoroughly clean and sanitize belts according to your standard sanitary operating procedures.

PREFORMED HEADED ROD

INSERT THE ROD

1. Join belt ends together so the hinges are aligned.
2. Insert the rod through the hinges until the rod head touches the belt edge.
3. Use a screwdriver to push the rod head into the belt while applying pressure down and away from the Snap-Lock.



Figure 22: Push rod into belt

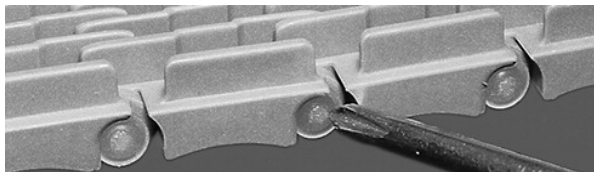

Figure 23: Ensure rod head is past snap-lock

4. Once properly inserted, cut the opposite end of the rod flush with the belt edge.



Figure 24: Cut rod flush with belt edge

REMOVE THE ROD

1. From the bottom of the belt, cut off the rod heads.
2. Use a screwdriver to push the rod out of the belt.

ABRASION RESISTANT ROD

INSERT THE ROD

1. Cut the rod heads from the old rod. See [Remove the Rod](#) for instructions.
2. Join belt ends together so the hinges are aligned.
3. Insert the new abrasion resistant rod through the hinges as far as possible.
4. Insert the rodlets on each end of the rod.
5. Use a screwdriver to push the rodlet head into the belt while applying pressure down and away from the Snap-Lock.

REMOVE THE ROD

1. From the bottom of the belt, cut off the rod heads.
2. Use the new abrasion resistant rod to push the old rod out of the belt. See [Insert the Rod](#) for instructions.

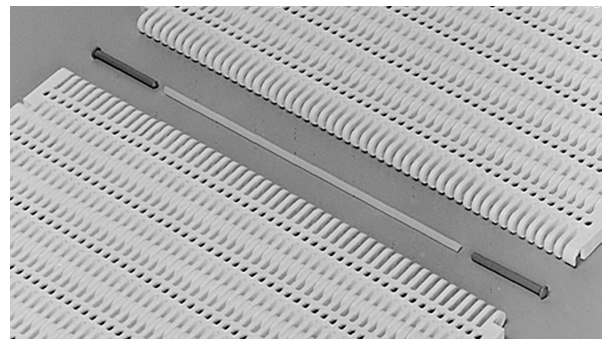

Figure 25: Abrasion resistant rod and rodlets

SPLICING NEW BELT WITH ORIGINAL BELT

A section of new Series 100 Flush Grid belt can be spliced into an existing belt. Alterations are only needed on the original rows.

1. On the edge of the original section of Series 100 Flush Grid or Raised Rib, cut the outermost link from the edge module.

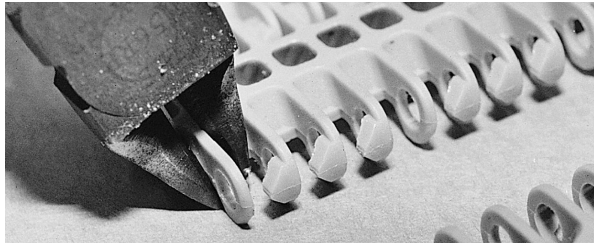

Figure 26: Cut outermost link

2. Snip off the triangular spacer tip on the second link.

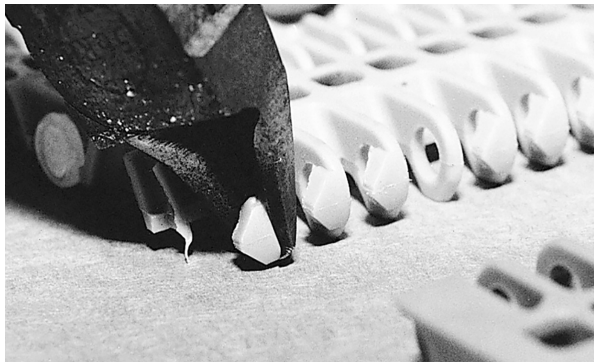

Figure 27: Cut spacer tip

3. Repeat steps 1 and 2 on the opposite edge of the belt.
4. Join belt ends together so the hinges are aligned.
5. Insert the rod through the hinges, starting on the side with the new Flush Grid module Snap-Lock.

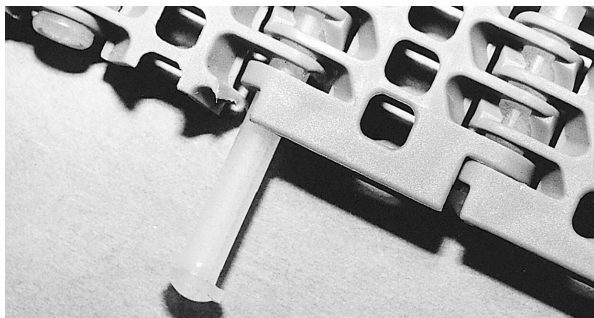

Figure 28: Insert rod

6. Repeat Steps 1 through 5 to splice the other side of the new belt to the original belt section.

SERIES 200-1

BELTS COVERED IN SECTION

- Open Grid
- Flush Grid
- Open Hinge

NOTE: Before use in food-safe applications, follow good manufacturing practice and thoroughly clean and sanitize belts according to your standard sanitary operating procedures.

THERMALLY FORMED HEADED ROD

INSERT THE ROD

1. Join belt ends together so the hinges are aligned.
2. Insert the rod through the hinges, leaving 0.25 in (6 mm) of rod protruding.

NOTE: DO NOT use an open flame to close rod holes.

3. Use an 80-watt soldering iron to head the rod. The finished rod head should be about 0.312 in (8 mm) in diameter.

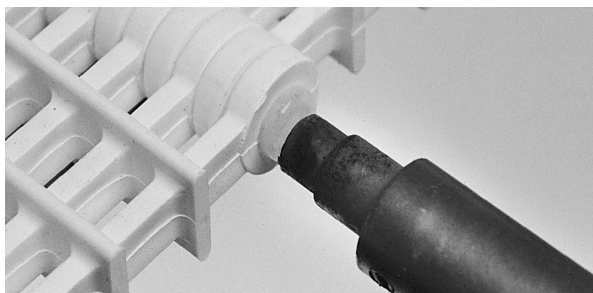

Figure 29: Head rod

4. Ensure all rods are headed on both sides of the belt.

REMOVE THE ROD

1. From the bottom of the belt, cut off the rod heads.
2. Use a screwdriver to push the rod out of the belt.

ABRASION RESISTANT ROD

On Series 200 belts with abrasion resistant rods, each rod is retained by melting the rod hole on both belt edges. The melted module material partially closes the rod hole.

NOTE: DO NOT use abrasion resistant rods on Series 200 Open Hinge belts.

INSERT THE ROD

1. Join belt ends together so the hinges are aligned.
2. Insert the new abrasion resistant rod through the hinges as far as possible.

NOTE: DO NOT use an open flame to close rod holes. DO NOT head abrasion resistant rods.

3. Use an 80-watt soldering iron to partially close the rod hole with the module material.

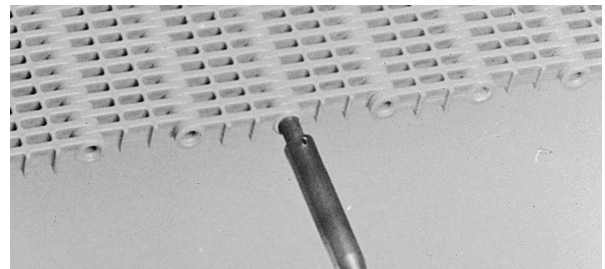

Figure 30: Close rod hole

4. Repeat step 3 on the rod hole on the opposite belt edge.

REMOVE THE ROD

1. Use a knife or sharp tool to open the partially closed rod hole.

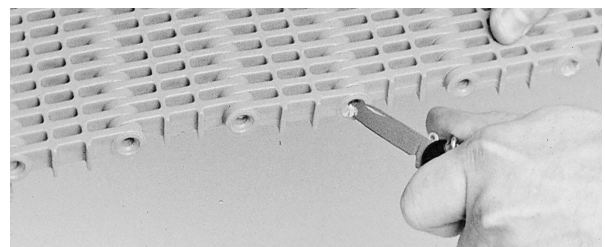

Figure 31: Open rod hole

SERIES 200-1

- On the opposite belt edge, use a screwdriver to push the rod out of the belt.

NOTE: DO NOT use sharp objects to push out the rod. Sharp objects can cause the rod to flare, making rod removal difficult.

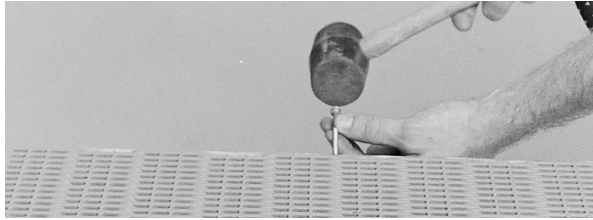
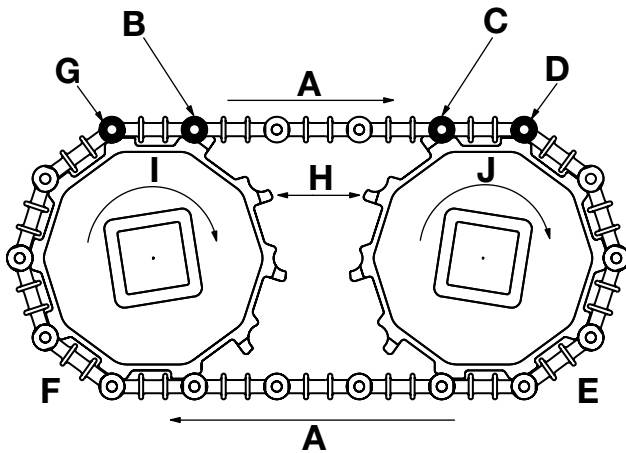

Figure 32: Push rod from belt

SPROCKET INSTALLATION & DIRECTION OF ROTATION

S200 sprockets are asymmetrical. They have a driving and idling direction of rotation. These sprockets must be placed on the shafts as shown in the following figure.



- A Belt travel
- B Note profile of sprocket tooth in idling position. Round hinge portion of the belt fits into the saddle behind the sprocket tooth.
- C Note profile of sprocket tooth in driving position. Round hinge portion of the belt fits into the saddle in front of the sprocket tooth.
- D In driving position, sprocket pushes belt.
- E Driving sprockets
- F Idling or take-up sprockets
- G In idling position, belt pushes sprocket.
- H Note teeth on drive and idler sprockets face in opposite directions
- I Idling Direction
- J Driving Direction

Figure 33: Sprocket installation

- All sprockets must be timed identically. Ensure all sprocket teeth line up in the same radial direction when looking down the shaft.

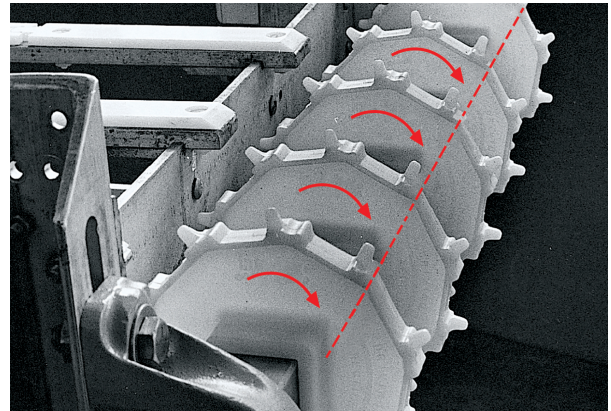

Figure 34: Align sprocket teeth

- On center-drive and push/pull bi-directional conveyors, reverse every other sprocket on the shaft.

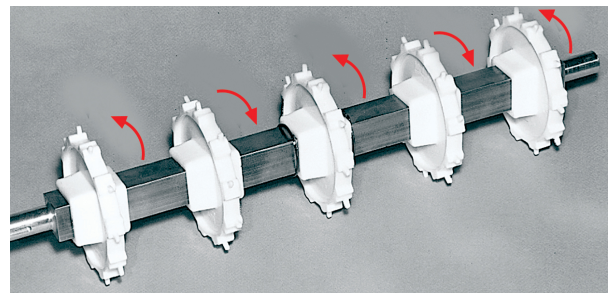
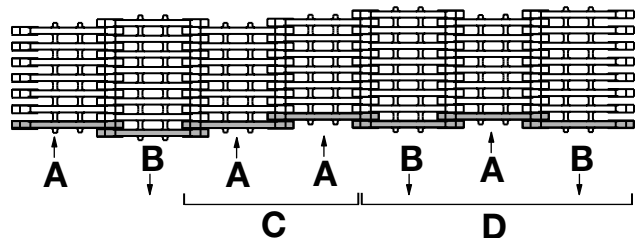

Figure 35: Reverse every other sprocket

LINKING BELT JOINTS

The edges of S200 belts cannot line up flush. The edges must have an in-and-out edge pattern.

NOTE: Series 200 belts must be removed in two-row increments to maintain the in-and-out belt edge. All Series 200 belts must have an even number of rows.



- A In
- B Out
- C Incorrect splicing
- D Correct splicing

Figure 36: Belt edges cannot be flush

SERIES 400-1

BELTS COVERED IN SECTION

- 0.85 in Diameter Transverse Roller Top™ (TRT™)
- Ball Belt
- Flush Grid
- Non Skid
- Raised Rib
- Roller Top
- Transverse Roller Top

NOTE: Before use in food-safe applications, follow good manufacturing practice and thoroughly clean and sanitize belts according to your standard sanitary operating procedures.

PREFORMED HEADED ROD

INSERT THE ROD

1. Join belt ends together so the hinges are aligned.
2. Insert the rod through the hinges until the rod head touches the belt edge.
3. Use a screwdriver to push the rod head into the belt while applying pressure down and away from the Snap-Lock.

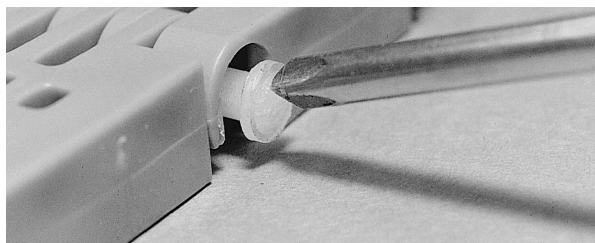

Figure 37: Push rod into belt

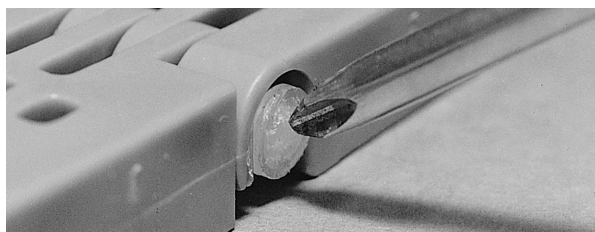

Figure 38: Ensure rod head is past snap-lock

4. Once properly inserted, cut the opposite end of the rod flush with the belt edge.



Figure 39: Cut rod flush with belt edge

REMOVE THE ROD

1. From the bottom of the belt, cut off the rod heads.
2. Use a screwdriver to push the rod out of the belt.

UNHEADED ROD & SLIDELOX RETAINER

INSERT THE ROD

1. On one belt edge, ensure the Slidelox is closed. If not, use a screwdriver to slide the latch to close the Slidelox.

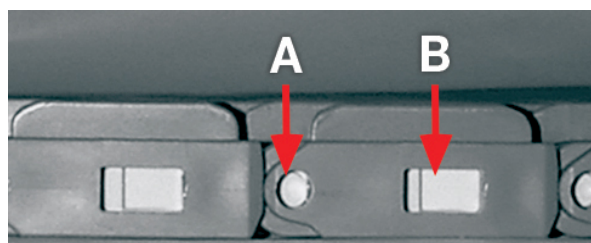

- A** Slidelox in closed position
- B** Latch

Figure 40: Slidelox components

2. On the opposite belt edge, ensure the Slidelox is open. If not, use a screwdriver to slide the latch to open the Slidelox.
3. Join belt ends together so the hinges are aligned.
4. Insert the rod through the open Slidelox.



Figure 41: Insert rod

5. Ensure the rod is inserted about 0.5 in (12.7 mm) past the belt edge.

- Once the rod is inserted, close the Slidelox. The Slidelox snaps when closed.

NOTE: Ensure ALL Slidelox are closed after installation.

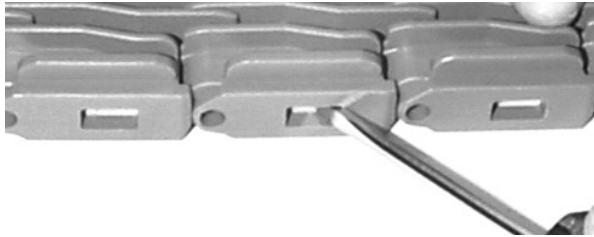

Figure 42: Close Slidelox

REMOVE THE ROD

- Use a screwdriver to open the Slidelox on both belt edges.



Figure 43: Open Slidelox

- Use a screwdriver to push the rod out of the belt.



Figure 44: Push rod from belt

- Once the rod is removed, slide the latch to close the Slidelox. The Slidelox snaps when closed.

NOTE: Ensure ALL Slidelox are closed after installation.

ABRASION RESISTANT ROD INSERT THE ROD

- Cut the rod heads from the old rod. See [Remove the Rod](#) for instructions.
- Join belt ends together so the hinges are aligned.
- Insert the new abrasion resistant rod through the hinges as far as possible.
- Insert the rodlets on each end of the rod.
- Use a screwdriver to push the rodlet head into the belt while applying pressure down and away from the Snap-Lock.

REMOVE THE ROD

- From the bottom of the belt, cut off the rod heads.
- Use the new abrasion resistant rod to push the old rod out of the belt. See [Insert the Rod](#) for instructions.

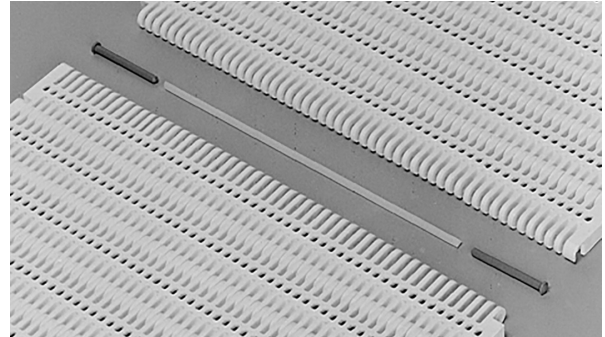

Figure 45: Abrasion resistant rod and rodlets

SPLICING A SLIDELOX BELT WITH A HEADED ROD BELT

If the existing retention features appear to be in good condition and headed rods are available, follow these steps:

- Insert a headed rod into the side of the belt opposite the Slidelox and push the rod into the retention feature.
- Once the rod is inserted, close the Slidelox. If the existing retention feature is not in good condition or there are no headed rods available, follow these steps:
 - Close the Slidelox on one side of the belt.
 - Insert a non-headed rod from the opposite side of the belt. The rod must be 1 in (25.4 mm) shorter than the width of the belt.
 - Use a blunt tip soldering iron or a heated round rod to melt the plastic around the rod hole on the belt until it is at least partially closed.

SPLICING FLUSH AND ORIGINAL EDGES

A new section of Series 400 Flush Grid or Raised Rib belt can be spliced into belts of the same style.

1. Bring the two belt ends close together, but do not join them.
2. Cut the outermost link from the original edge module on both sides of the belt.

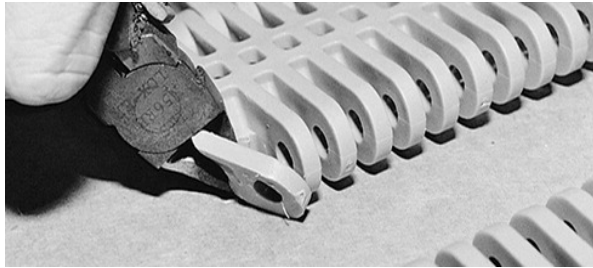

Figure 46: Cut outermost link

3. If splicing a Raised Rib belt, cut the outermost rib from the original edge module on both sides of the belt to allow for back bend. If not, proceed to the next step.



Figure 47: Cut outermost rib

4. Join belt ends together so the hinges are aligned.
5. Starting on the side of the new Flush Edge module with the Snap-Lock, insert the rod through the hinges, leaving just the rod head protruding.

6. Use a screwdriver to push the rod head into the belt while applying pressure down and away from the Snap-Lock.

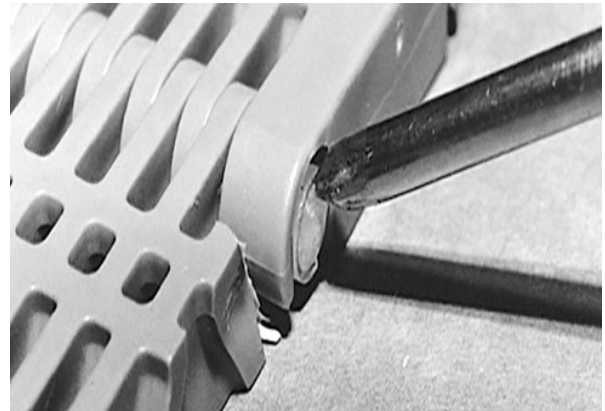

Figure 48: Push rod head past retention feature

7. Once properly inserted, cut the opposite end of the rod flush with the belt edge.

SERIES 400-2

BELTS COVERED IN SECTION

- Open Hinge

NOTE: Before use in food-safe applications, follow good manufacturing practice and thoroughly clean and sanitize belts according to your standard sanitary operating procedures.

THERMALLY FORMED HEADED ROD

INSERT THE ROD

1. Join belt ends together so the hinges are aligned.
2. Insert the rod through the hinges, leaving 0.25 in (6 mm) of rod protruding.

NOTE: DO NOT use an open flame to close rod holes.

3. Use an 80-watt soldering iron to head the rod. The finished rod head should be about 0.312 in (8 mm) in diameter.
4. Ensure all rods are headed on both sides of the belt.

REMOVE THE ROD

1. From the bottom of the belt, cut off the rod heads.
2. Use a screwdriver to push the rod out of the belt.

SERIES 400-3

BELTS COVERED IN SECTION

- 0.78 in Diameter 90-Degree Angled Roller™
- 0-Degree, 30-Degree, 45-Degree, 60-Degree & 90-Degree Angled Roller

NOTE: Before use in food-safe applications, follow good manufacturing practice and thoroughly clean and sanitize belts according to your standard sanitary operating procedures.

UNHEADED ROD

INSERT THE ROD

1. Cut rods 1.75 in (44.5 mm) shorter than the overall belt width.
2. Join belt ends together so the hinges are aligned.
3. Insert the rod through the hinges as far as possible.

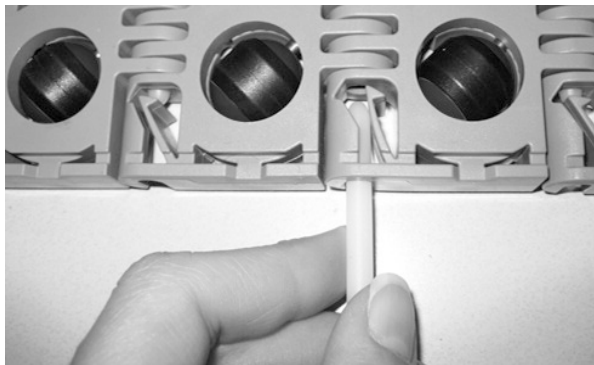

Figure 49: Insert rod through hinges

4. Use a screwdriver to push the rod past the retention feature.

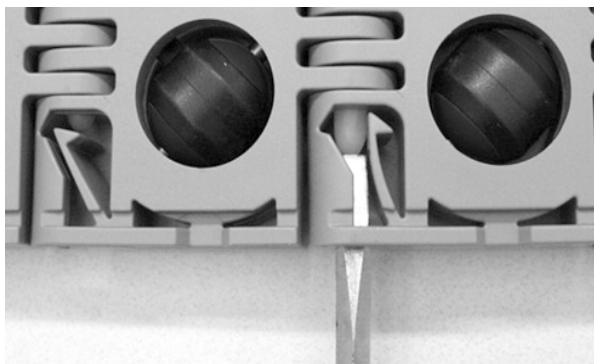

Figure 50: Push rod past retention feature

5. Ensure the retention feature is fully closed.

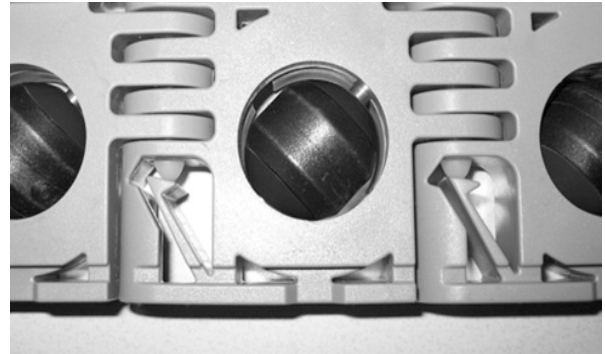

Figure 51: Ensure retention feature

REMOVE THE ROD

1. On one belt edge, use a screwdriver to push the retention feature open.
2. On the opposite belt edge, use a screwdriver to push the rod out of the belt.

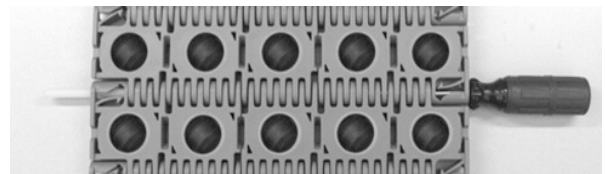

Figure 52: Push rod from belt

SERIES 550-1

BELTS COVERED IN SECTION

- Tight Transfer Flat Top

NOTE: Before use in food-safe applications, follow good manufacturing practice and thoroughly clean and sanitize belts according to your standard sanitary operating procedures.

UNHEADED ROD

INSERT THE ROD

1. Cut rods 0.312 in (8 mm) shorter than the overall belt width.
2. Join belt ends together so the hinges are aligned.
3. Insert the rod through the hinges as far as possible.

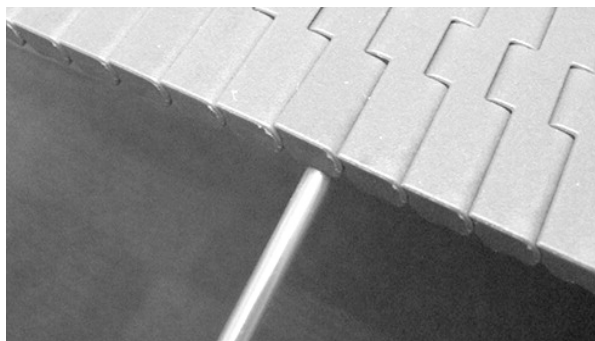

Figure 53: Insert rod

4. Use a screwdriver to push the rod past the retention feature.



Figure 54: Push rod head past retention feature

5. Ensure the rod is fully seated past the retention feature.

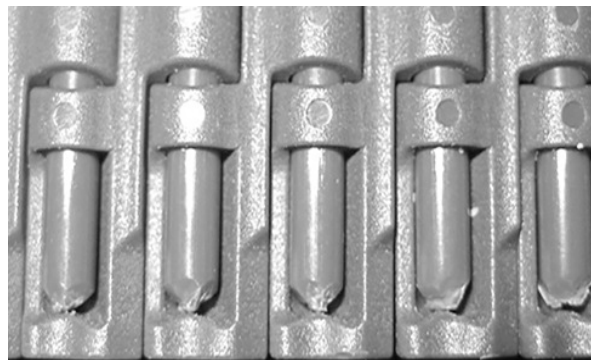

Figure 55: Ensure rod is past retention feature

REMOVE THE ROD

1. On the bottom side of the belt, insert a screwdriver between the rod and the belt.
2. Twist the screwdriver to lift the rod over the retention feature. Repeat this process until the rod tip is past the belt edge.

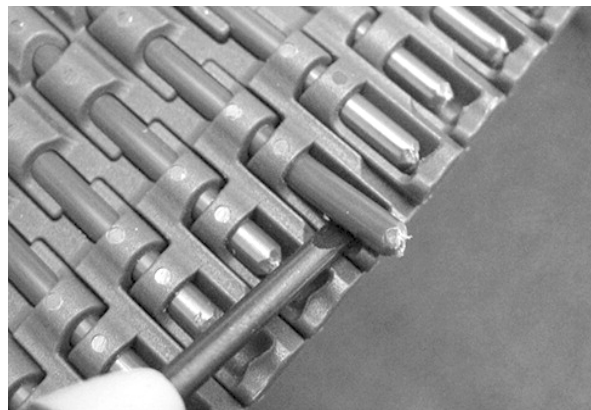

Figure 56: Lift rod over retention feature

3. Once past the belt edge, pull the rod out to open the belt.

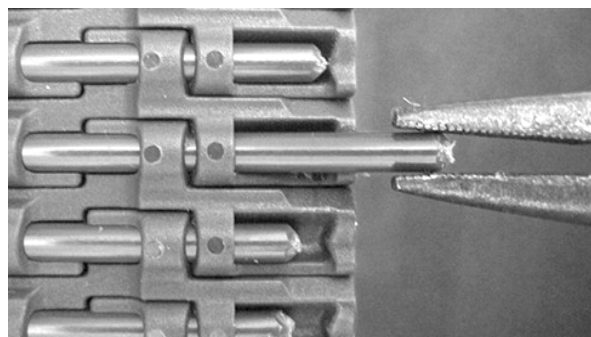

Figure 57: Pull rod from belt

SERIES 560-1

BELTS COVERED IN SECTION

- Flat Top
- Flush Grid

NOTE: Before use in food-safe applications, follow good manufacturing practice and thoroughly clean and sanitize belts according to your standard sanitary operating procedures.

UNHEADED ROD

INSERT THE ROD

1. Join belt ends together so the hinges are aligned.
2. Insert the rod through the hinges as far as possible.

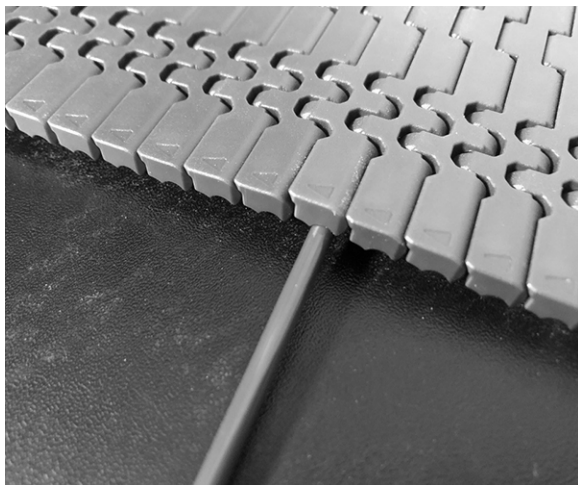

Figure 58: Insert rod

3. Use a screwdriver to push the rod past the retention feature.



Figure 59: Push rod past retention feature

4. Ensure the rod is fully seated past the retention feature.

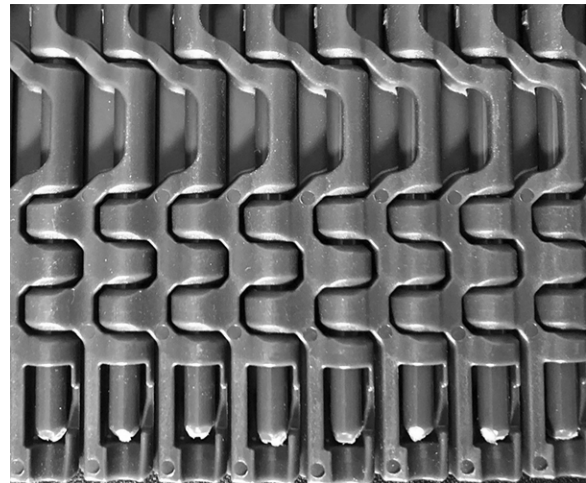

Figure 60: Ensure rod is seated past retention feature

REMOVE THE ROD

1. On the bottom side of the belt, insert a screwdriver between the rod and the belt.
2. Twist the screwdriver to lift the rod over the retention feature. Repeat this process until the rod tip is past the belt edge.

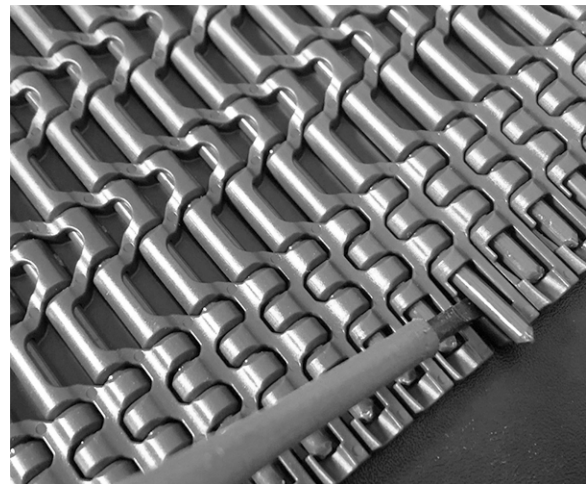

Figure 61: Lift rod over retention feature

SERIES 560-1

3. Once past the belt edge, pull the rod out to open the belt.

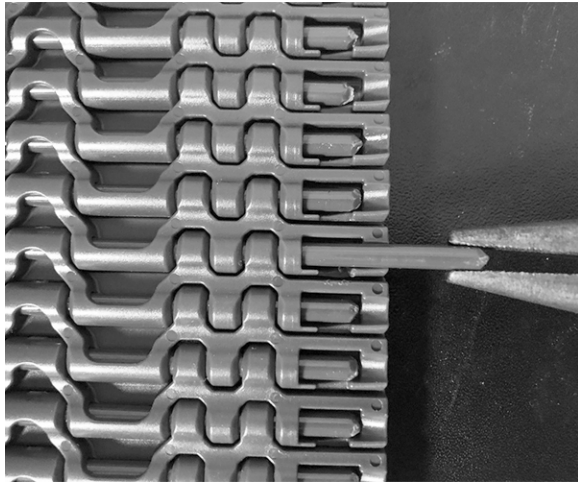

Figure 62: Pull rod out

SERIES 800-1

BELTS COVERED IN SECTION

- Cone Top™
- Flat Top
- Mesh Top™
- Mini Rib
- Nub Top™
- Perforated Flat Top
- Perforated Flat Top Round Hole
- Roller Top
- Rounded Friction Top
- Tough Flat Top

NOTE: Before use in food-safe applications, follow good manufacturing practice and thoroughly clean and sanitize belts according to your standard sanitary operating procedures.

PREFORMED HEADED ROD

INSERT THE ROD

1. Join belt ends together so the hinges are aligned.
2. Insert the rod through the hinges until the rod head touches the belt edge.
3. Use a screwdriver to push the rod head into the belt while applying pressure down and away from the Snap-Lock.



Figure 63: Push rod into belt

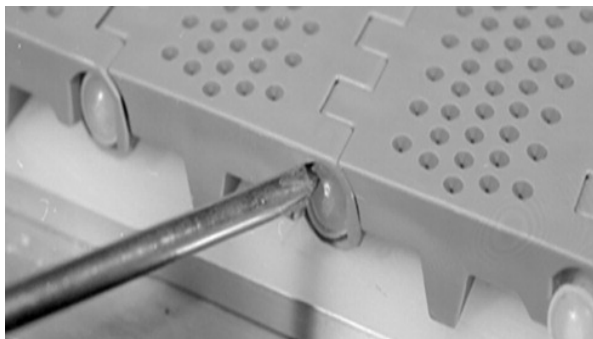

Figure 64: Ensure rod head is past snap-lock

4. Once properly inserted, cut the opposite end of the rod flush with the belt edge.

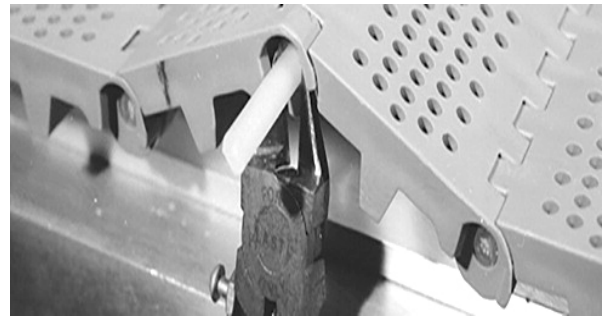

Figure 65: Cut rod flush with belt edge

REMOVE THE ROD

1. From the bottom of the belt, cut off the rod heads.
2. Use a screwdriver to push the rod out of the belt.

ABRASION RESISTANT ROD

INSERT THE ROD

1. Cut the rod heads from the old rod. See [Remove the Rod](#) for instructions.
2. Join belt ends together so the hinges are aligned.
3. Insert the new abrasion resistant rod through the hinges as far as possible.
4. Insert the rodlets on each end of the rod.
5. Use a screwdriver to push the rodlet head into the belt while applying pressure down and away from the Snap-Lock.

REMOVE THE ROD

1. From the bottom of the belt, cut off the rod heads.
2. Use the new abrasion resistant rod to push the old rod out of the belt. See [Insert the Rod](#) for instructions.

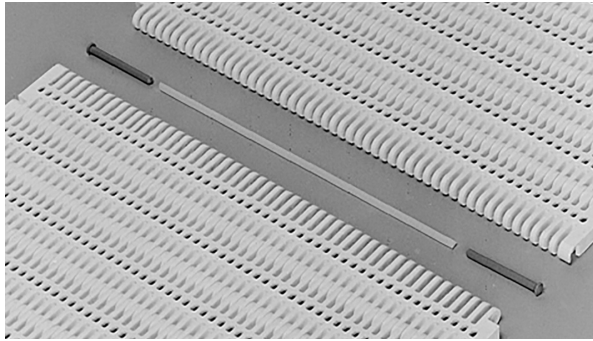

Figure 66: Abrasion resistant rod and rodlets

SERIES 800-2

BELTS COVERED IN SECTION

- Open Hinge Cone Top™
- Open Hinge Flat Top
- SeamFree™ Open Hinge Cone Top™
- SeamFree Open Hinge Flat Top
- SeamFree Open Hinge Nub Top™

NOTE: Before use in food-safe applications, follow good manufacturing practice and thoroughly clean and sanitize belts according to your standard sanitary operating procedures.

PREFORMED HEADED ROD

INSERT THE ROD

1. Cut rods 0.75 in (19 mm) shorter than the overall belt width.
2. Join belt ends together so the hinges are aligned.
3. Insert the rod through the hinges until the rod head touches the belt edge.

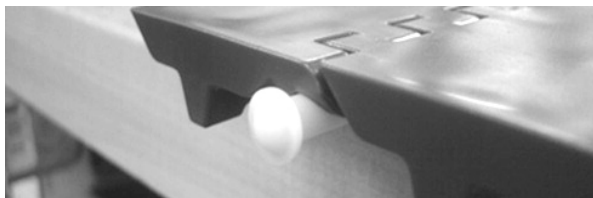

Figure 67: Insert rod through hinges

4. Use your thumb to push the rod head forward until it snaps into the retention feature.

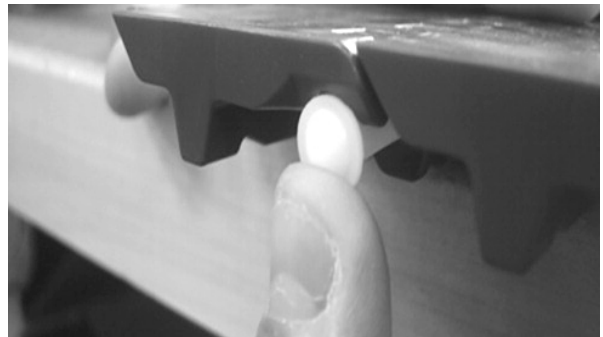

Figure 68: Use thumb to push rod

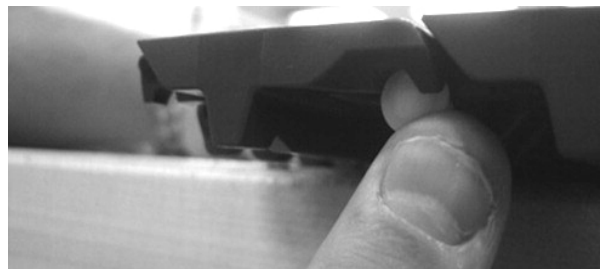

Figure 69: Push rod past retention feature

5. Ensure the rod is fully inserted.



Figure 70: Ensure rod is past retention feature

REMOVE THE ROD

1. From the bottom of the belt, cut off the rod heads.

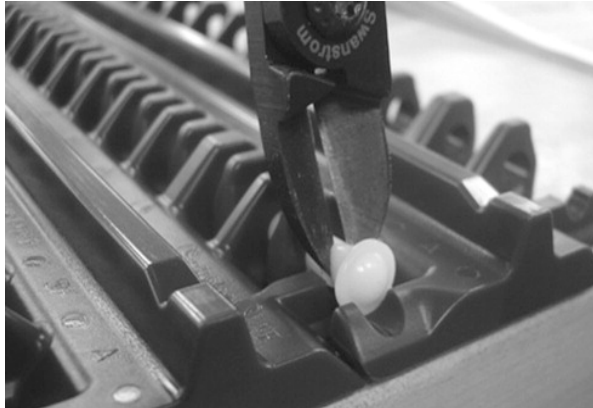

Figure 71: Cut rod head

2. Grip and pull the rod out to open the belt.



Figure 72: Pull rod from belt

SPLICING NEW OPEN HINGE FLUSH EDGE (A) WITH OLD FLUSH EDGE (B)

Connecting the edge of the updated design (A) to the edge of the original design (B) allows for non-destructive assembly.

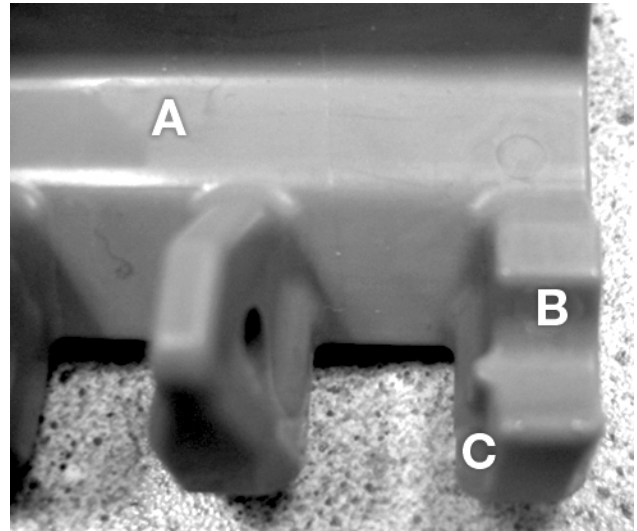

- A Old design
- B Taller vertical face
- C Vertical ledge

Figure 73: Original Flush Edge hinges

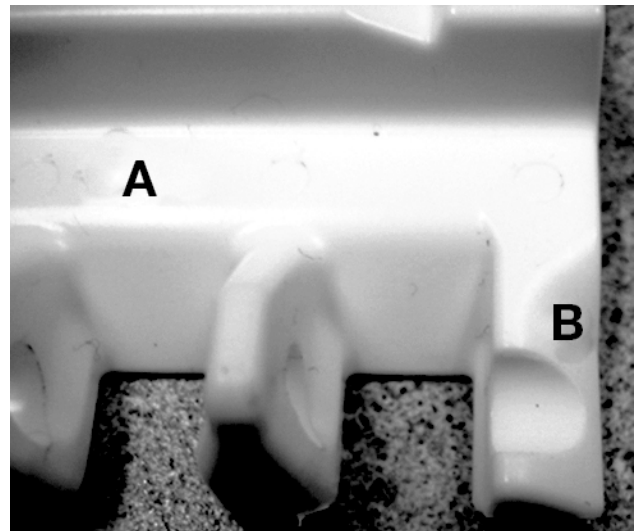

- A Updated design
- B Shorter angled face

Figure 74: Updated Open Hinge Flush Edge hinges

- 1. Join the old (B) and new (A) sections so the old section (B) is on the left and the new section (A) is on the right.

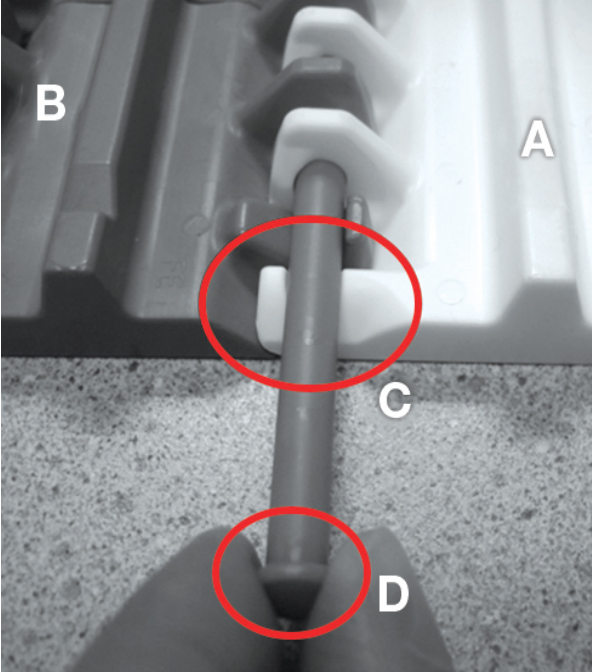

A Updated design
B Original design
C New rod retention geometry
D Rod head

Figure 75: Properly position belt sections

NOTE: DO NOT use an unheaded rod. Ensure the old and new sections are properly oriented before inserting the rod.

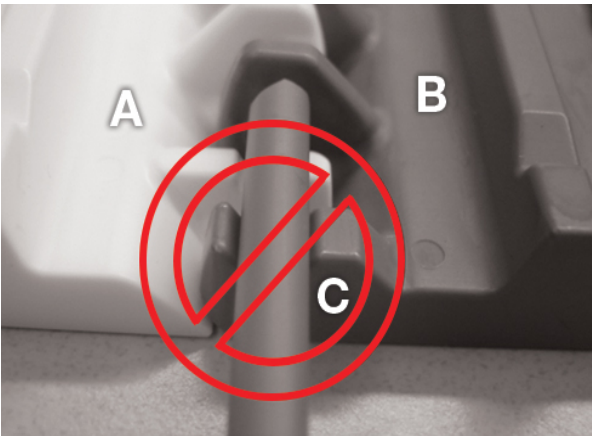

A Updated design
B Original design
C Old rod retention geometry

Figure 76: Properly position belt sections

- 2. Insert the rod through the hinges until the rod head touches the belt edge.

- 3. Use your thumb to push the rod head forward until it snaps into the retention feature.

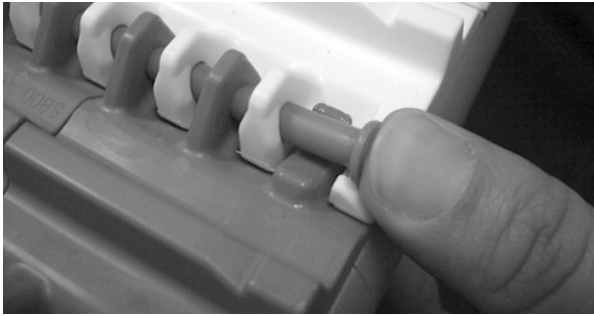
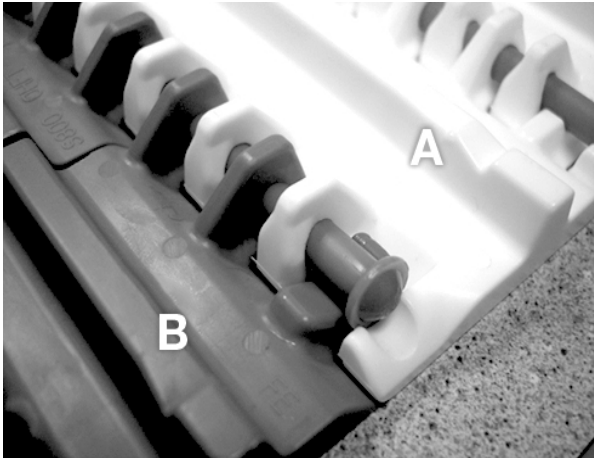

Figure 77: Push rod past retention feature

- 4. Ensure the rod is fully inserted as shown.



A Updated design
B Original design

Figure 78: Ensure rod is past retention feature

SERIES 800-3

BELTS COVERED IN SECTION

- Flush Grid
- Flush Grid Nub Top™

NOTE: Before use in food-safe applications, follow good manufacturing practice and thoroughly clean and sanitize belts according to your standard sanitary operating procedures.

UNHEADED ROD

INSERT THE ROD

1. Cut rods 0.5 in (12.7 mm) shorter than the overall belt width.
2. Join belt ends together so the hinges are aligned.
3. Insert the rod through the hinges as far as possible.



Figure 79: Push rod into belt

4. Use a screwdriver to push the rod past the retention feature.

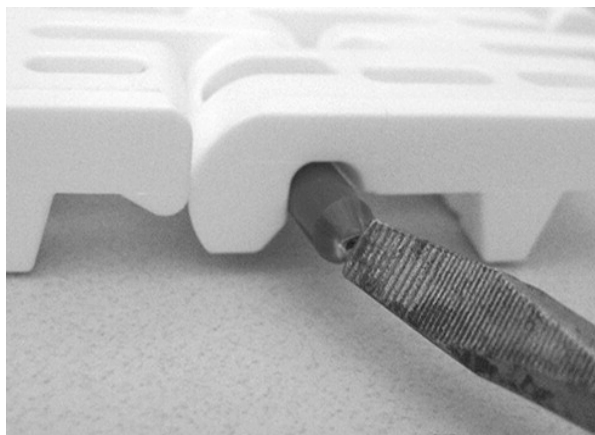

Figure 80: Push rod past retention feature

5. Ensure the rod is fully inserted.

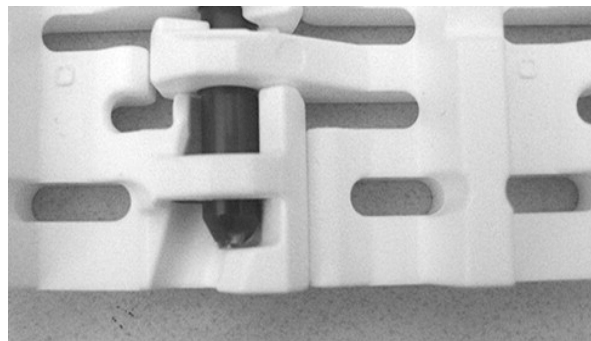

Figure 81: Ensure rod is fully inserted

REMOVE THE ROD

1. On the bottom side of the belt, insert a screwdriver between the rod and the belt.
2. Twist the screwdriver to lift the rod over the retention feature. Repeat this process until the rod tip is past the belt edge.

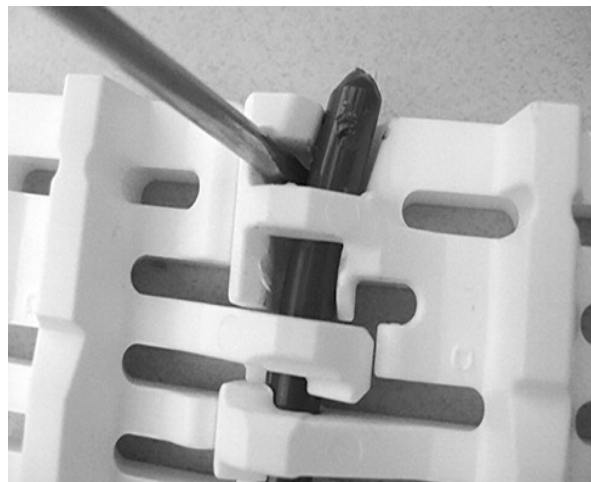

Figure 82: Lift rod past retention feature

SERIES 800-3

3. Once past the belt edge, pull the rod out to open the belt.

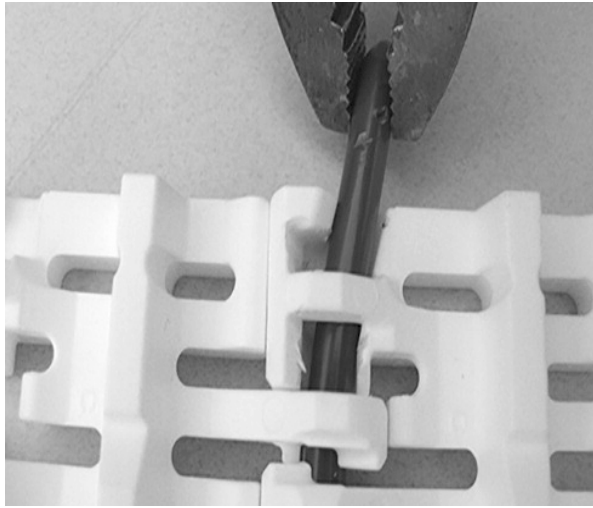

Figure 83: Pull rod from belt

SERIES 800-4

BELTS COVERED IN SECTION

- Raised Rib

NOTE: Before use in food-safe applications, follow good manufacturing practice and thoroughly clean and sanitize belts according to your standard sanitary operating procedures.

UNHEADED ROD

INSERT THE ROD

1. Join belt ends together so the hinges are aligned.
2. Insert the rod through the hinges as far as possible.

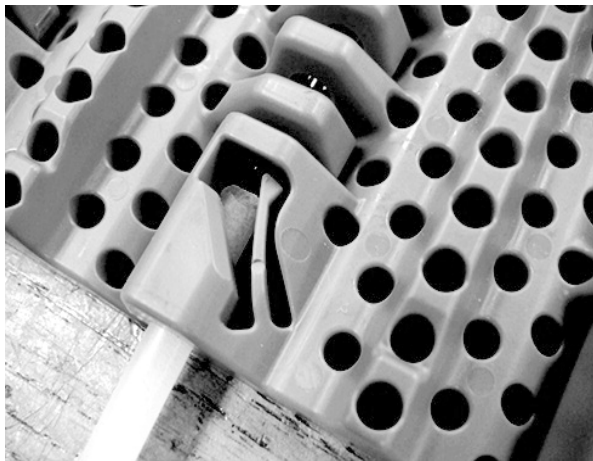

Figure 84: Push rod into belt

3. Use a screwdriver to push the rod past the retention feature.

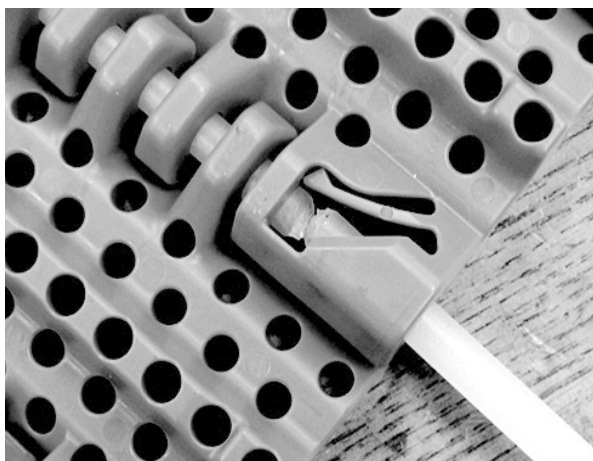

Figure 85: Push rod past retention feature

4. Ensure the rod is fully inserted.

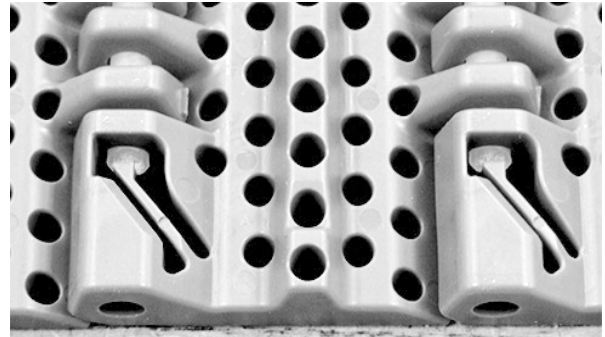

Figure 86: Ensure rod is past retention feature

REMOVE THE ROD

1. On one belt edge, use a screwdriver to push the retention feature open.
2. On the opposite belt edge, use a screwdriver to push the rod out of the belt.

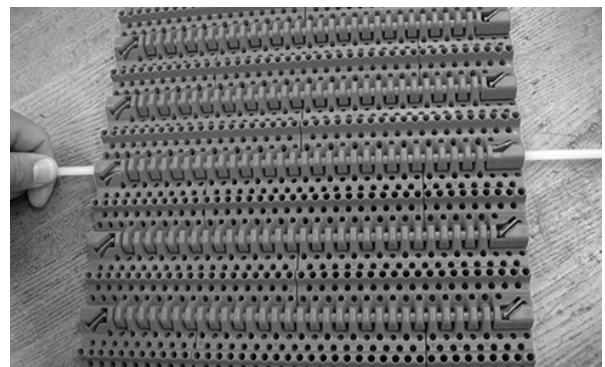

Figure 87: Pull rod from belt

SERIES 800-5

BELTS COVERED IN SECTION

- Open Hinge Flat Top with Heavy-Duty Edge

NOTE: Before use in food-safe applications, follow good manufacturing practice and thoroughly clean and sanitize belts according to your standard sanitary operating procedures.

UNHEADED ROD

INSERT THE ROD

1. Join belt ends together so the hinges are aligned.
2. Slightly bend and insert the rod through the hinges until rod is fully seated within the edge.



Figure 88: Slightly bend and insert rod through hinges

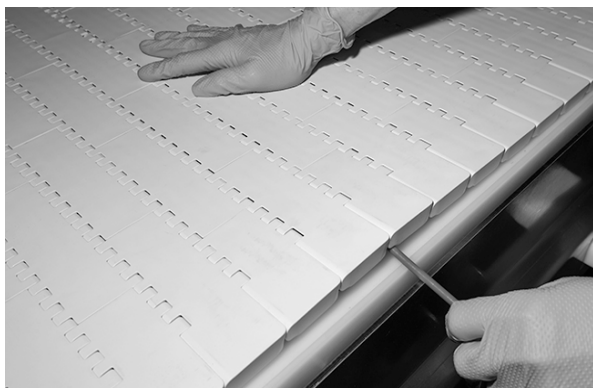

Figure 89: Push rod through the hinges until fully seated

REMOVE THE ROD

1. From the belt bottom, place the wide end of a flat-head screwdriver underneath rod.
2. Rotate the flat-head screwdriver outward, away from the belt center, until the rod moves past the belt edge.



Figure 90: Twist screwdriver

3. Once past the belt edge, pull the rod out to open the belt.

SPROCKET SPACERS

OVERVIEW

Intralox sprocket spacers are designed to provide a cost-effective, food-safe method of maintaining the recommended distance between sprockets.

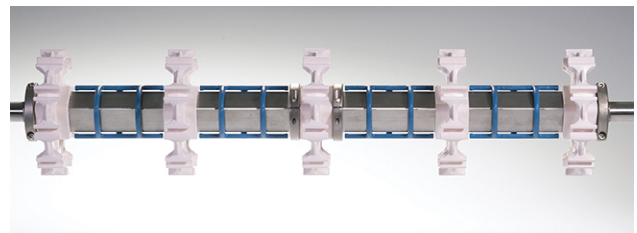

Figure 91: Sprocket spacer on shaft

SETUP

1. Contact Intralox Customer Service for a sprocket spacer specification for your application. See [Sprocket Spacer Specifications](#) for example specifications.
2. Identify the shaft centerline.

SPROCKET SPACER SPECIFICATIONS

The following figure is an example only. Contact Intralox Customer Service for an actual specification and part quantities for your application.

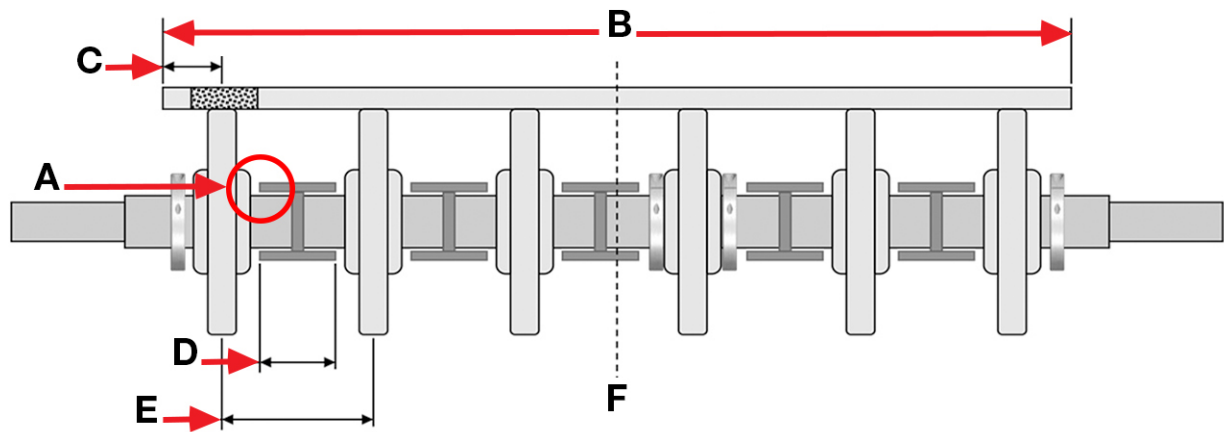

- A Distance between sprocket and spacer
- B Belt width
- C Sprocket offset
- D Sprocket spacer width
- E Distance between sprockets
- F Shaft centerline

Figure 92: Example drive shaft specification

SETUP

1. Detach the shaft from the conveyor frame.



Follow all appropriate lockout/tagout and safety procedures, and use appropriate PPE.

2. If retrofitting an existing conveyor, remove any existing sprockets and retainer rings from the shaft.
3. Attach a retainer ring on one end of the shaft. Use the specifications provided by Intralox Customer Service to determine the proper location.
4. Place the outermost sprocket on the shaft.
5. Place a sprocket spacer on the shaft.

6. Ensure the flat feature on the spacer is against the flat of the shaft.

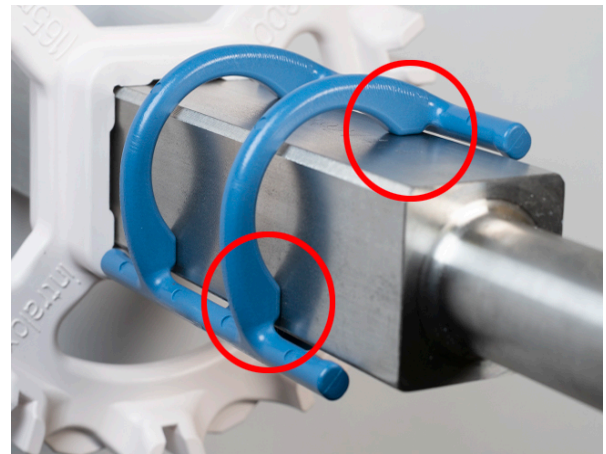
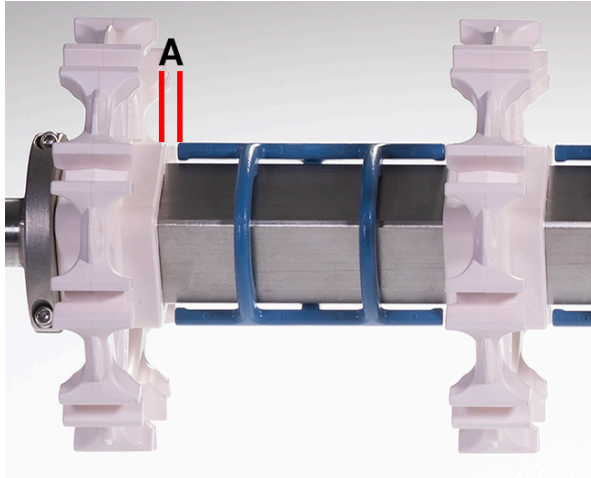

Figure 93: Ensure spacer is flat against shaft

- Slide the sprocket spacer toward the sprocket. Use the specifications provided by Intralox Customer Service to determine the recommended distance between the sprocket and the spacer.



A Distance between sprocket and spacer

Figure 94: Distance between sprocket and spacer

- Slide a sprocket onto the shaft, leaving the recommended distance between the sprockets.
- Continue sliding sprockets and spacers onto the shaft, leaving equal distance between each sprocket and spacer, up to the shaft centerline.
- At the shaft centerline, following the provided specification, place a retainer ring on the shaft.

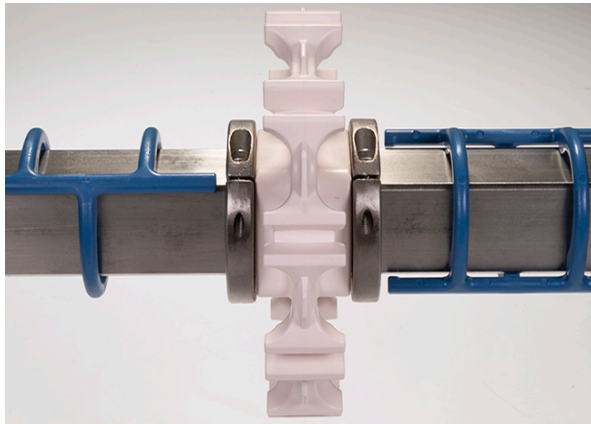

Figure 95: Place retainer ring at centerline

- Position and lock the center sprocket.
- Place a retainer ring on the shaft.
- Continue adding spacers and sprockets to the shaft, leaving equal distance between each sprocket and spacer, until all sprockets and spacers are on the shaft.
- Attach a retainer ring to the end of the shaft.
- Attach the shaft to the conveyor frame.

SERIES 850-1

BELTS COVERED IN SECTION

- SeamFree™ Minimum Hinge Cone Top™
- SeamFree Minimum Hinge Flat Top
- SeamFree Minimum Hinge NubTop

NOTE: Before use in food-safe applications, follow good manufacturing practice and thoroughly clean and sanitize belts according to your standard sanitary operating procedures.

PREFORMED HEADED ROD

INSERT THE ROD

1. Cut rods 0.75 in (19 mm) shorter than the overall belt width.
2. Join belt ends together so the hinges are aligned.
3. Insert the rod through the hinges until the rod head touches the belt edge.

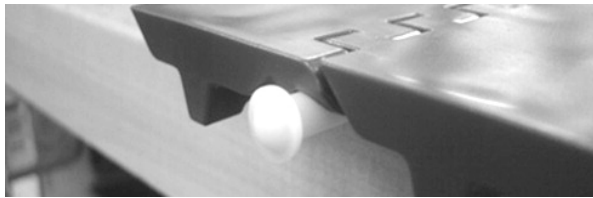

Figure 96: Insert rod through hinges

4. Use your thumb to push the rod head forward until it snaps into the retention feature.

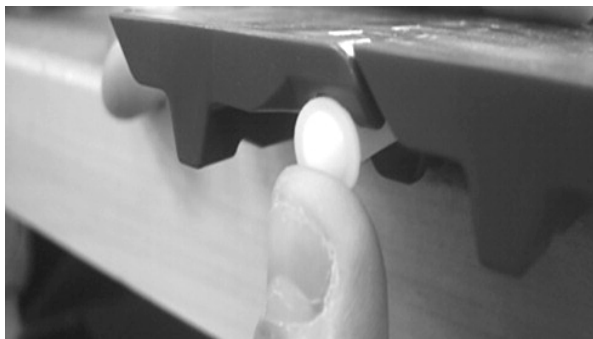

Figure 97: Use thumb to push rod

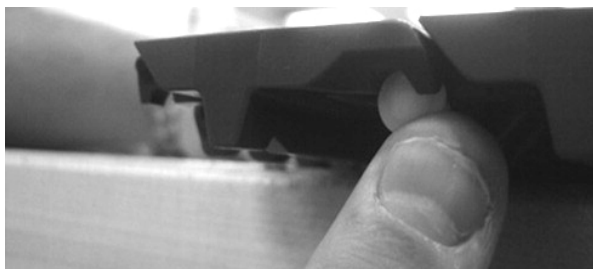

Figure 98: Push rod past retention feature

5. Ensure the rod is fully inserted.

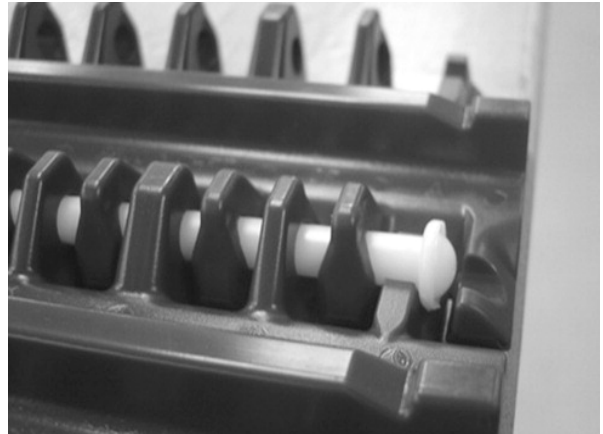

Figure 99: Ensure rod is past retention feature

REMOVE THE ROD

1. From the bottom of the belt, cut off the rod heads.

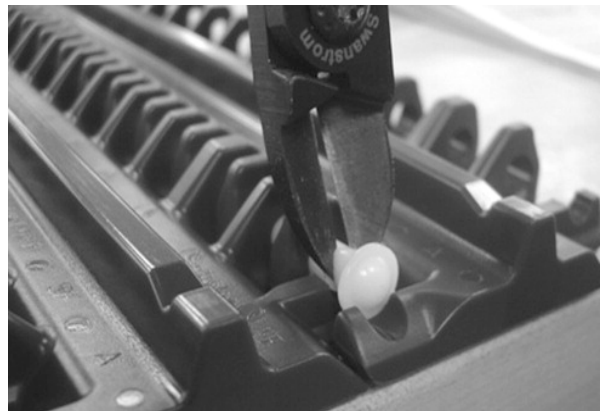

Figure 100: Cut rod head

2. Grip and pull the rod out to open the belt.



Figure 101: Pull rod from belt

SERIES 888-1

BELTS COVERED IN SECTION

- Medium Slot
- Medium Slot Stainless Steel Link (SSL)
- Large Slot Stainless Steel Link (SSL)

NOTE: Before use in food-safe applications, follow good manufacturing practice and thoroughly clean and sanitize belts according to your standard sanitary operating procedures.

CHECK BELT ALIGNMENT

Before joining belt ends, ensure the modules and stainless steel links (if Medium Slot SSL or Large Slot SSL) are properly aligned down the length of the belt.

1. Place a flat material over the returnway and below the belt.

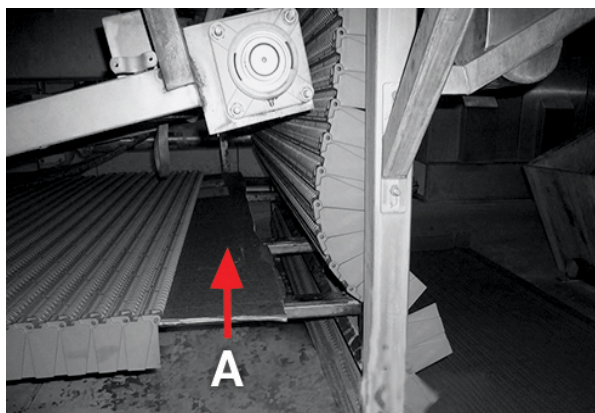

A Flat material over returnway

Figure 102: Place material over returnway

2. Inspect the modules down the belt length and ensure the modules and any stainless steel links are properly aligned.

UNHEADED ROD

INSERT THE ROD

1. Join belt ends together so the hinges are aligned.
2. Insert the rod through the hinges as far as possible.



Figure 103: Insert rod through hinges

3. Use a screwdriver to push the rod past the retention feature.



Figure 104: Push rod past retention feature

4. Ensure the rod is fully inserted.



Figure 105: Ensure retention feature is closed

REMOVE THE ROD

1. On one belt edge, use a screwdriver to push the retention feature open.

2. On the opposite belt edge, use a screwdriver to push the rod out of the belt.

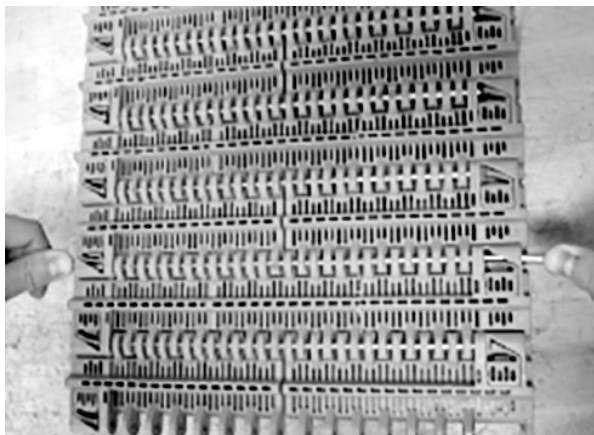

Figure 106: Pull rod from belt

MEDIUM SLOT (WITHOUT STAINLESS STEEL LINKS) SPROCKET INSTALLATION

Series 888 sprockets do not have a tracking element and Series 888 belts do not have any particular center sprocket position.

1. Position the drive and idle sprockets at least 2 in (51 mm) away from the belt edge and use retainer rings to lock them in place. The edge module rod retention feature prevents sprocket engagement in this 2 in (51 mm) wide area.
2. Equally space all other sprockets approximately 4 in (100 mm) apart.
3. Use two retainer rings per sprocket to lock all sprockets in position.

MEDIUM AND LARGE SLOT (WITH STAINLESS STEEL LINKS) SPROCKET INSTALLATION

- Series 888 Medium and Large Slot SSL belts have several stainless steel links across the belt width. It is crucial that the sprockets do not interfere with any of these stainless steel links.
- The exact operating belt width and position of all stainless steel links depends on:
 - The bricklay pattern of each belt width. Belts can be built in 0.66 in (16.8 mm) increments.
 - Thermal expansion of the belt width (consider max. production and cleaning temperatures)

- Belt building tolerances

1. Place one belt section next to the shaft and use this belt section to position all of the sprockets.
2. Using a marker, indicate the belt run direction on this belt section to ensure that sprockets on the drive and idle shafts are placed in the same orientation.

NOTE: The belt is bi-directional, but the patterns are usually not symmetrical about a centerline. The stainless steel links must be aligned in the same orientation. A section cannot be switched end-for-end and mated properly with the next section.

3. Using the location of the stainless steel links and the belt run direction, locate the seven-link modules in every second belt row as close to the conveyor centerline as possible.
4. Place two sprockets near the stainless steel links at the opposite ends of the central seven-link module.
5. Depending on the belt width, space three or four sprockets about 4 in (100 mm) apart on each side of the first two sprockets (counting from belt center).
6. Place additional sprockets outside (outboard) of any outer stainless steel link (of a pair) in the area where a sprocket is needed, but allow about 1 in (25 mm) clearance.
7. After securing the sprockets in place (without any play), wrap the belt section around the sprockets to ensure there is no interference with any of the stainless steel links and there is enough clearance for expansion.

SERIES 888-2

BELTS COVERED IN SECTION

- Round Hole Enhanced

NOTE: Before use in food-safe applications, follow good manufacturing practice and thoroughly clean and sanitize belts according to your standard sanitary operating procedures.

UNHEADED ROD

INSERT THE ROD

1. Join belt ends together so the hinges are aligned.
2. Insert the rod through the hinges as far as possible.
3. Use a screwdriver to push the rod past the retention feature.

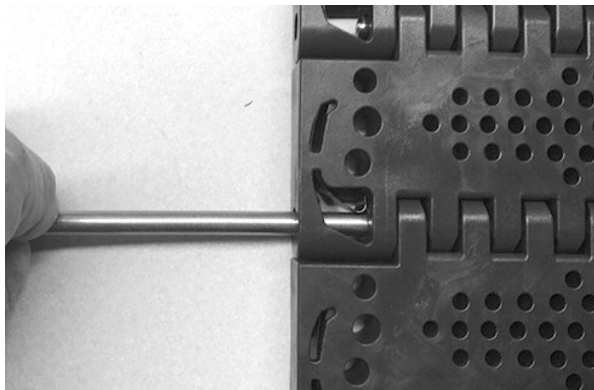

Figure 107: Push rod past retention feature

4. Ensure the rod is fully inserted.

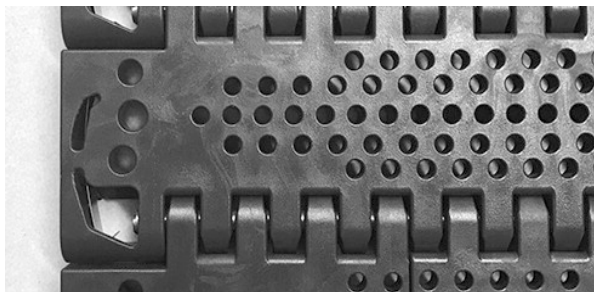

Figure 108: Ensure rod is fully inserted

REMOVE THE ROD

1. On one belt edge, use a screwdriver to push the retention feature open.

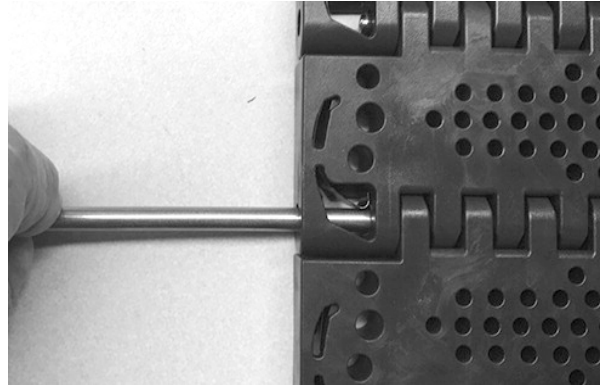

Figure 109: Push rod from belt

2. On the opposite belt edge, use a screwdriver to push the rod out of the belt.

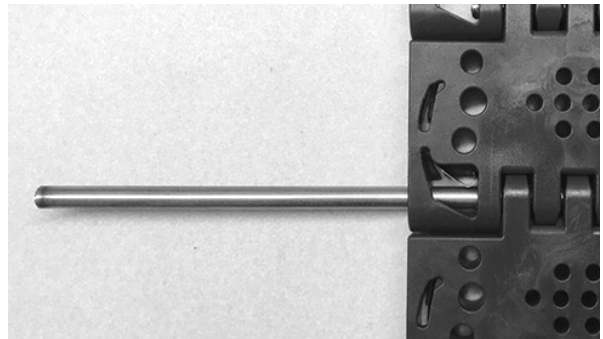

Figure 110: Push rod from belt

SERIES 900-1

BELTS COVERED IN SECTION

- Diamond Friction Top
- Flat Friction Top
- Flat Top
- Flush Grid
- Flush Grid Nub Top™
- Flush Grid with Insert Rollers
- Mesh Top™
- Mold to Width 29 mm Square Friction Top
- Mold to Width Flat Top
- Mold to Width Flat Top with Holes
- Mold to Width Flush Grid
- Mold to Width Raised Rib
- Nub Top™
- ONEPIECE™ Live Transfer Flat Top
- ONEPIECE™ Live Transfer Flush Grid
- Open Grid
- Perforated Flat Top
- Raised Rib
- Square Friction Top

NOTE: Before use in food-safe applications, follow good manufacturing practice and thoroughly clean and sanitize belts according to your standard sanitary operating procedures.

PREFORMED HEADED ROD

INSERT THE ROD

1. Join belt ends together so the hinges are aligned.
2. Insert the rod through the hinges until the rod head touches the belt edge.

3. Use a screwdriver to push the rod head into the belt while applying pressure down and away from the Snap-Lock.

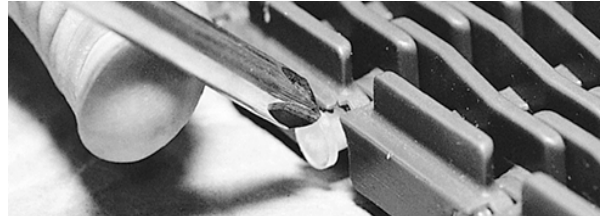

Figure 111: Push rod into belt

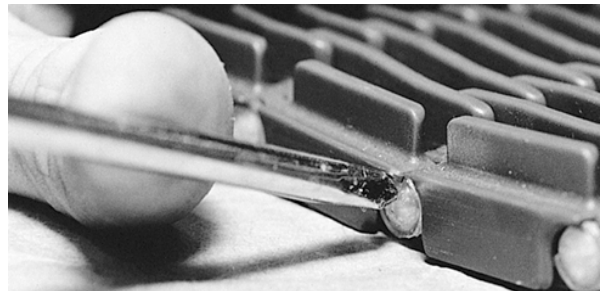

Figure 112: Ensure rod is past snap-lock

4. Once properly inserted, cut the opposite end of the rod flush with the belt edge.

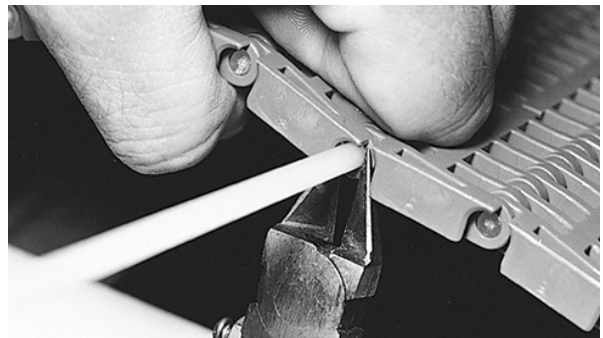

Figure 113: Cut rod flush with belt edge

REMOVE THE ROD

1. From the bottom of the belt, cut off the rod heads.
2. Use a screwdriver to push the rod out of the belt.

ABRASION RESISTANT ROD INSERT THE ROD

1. Cut the rod heads from the old rod. See [Remove the Rod](#) for instructions.
2. Join belt ends together so the hinges are aligned.
3. Insert the new abrasion resistant rod through the hinges as far as possible.
4. Insert the rodlets on each end of the rod.
5. Use a screwdriver to push the rodlet head into the belt while applying pressure down and away from the Snap-Lock.

REMOVE THE ROD

1. From the bottom of the belt, cut off the rod heads.
2. Use the new abrasion resistant rod to push the old rod out of the belt. See [Insert the Rod](#) for instructions.

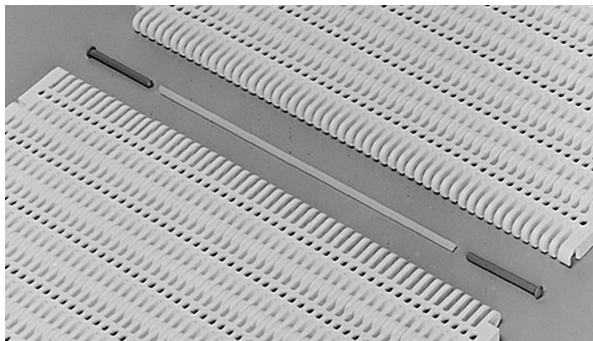

Figure 114: Abrasion resistant rod and rodlets

FRICION TOP BELT RETURNWAY REQUIREMENTS

- Due to the high friction belt surface, avoid rubbing or sliding friction on the return side of conveyors using S900 Friction Top belts.
- Use shoes or rollers on the outer edges of belts using edge modules with no rubber surface.

MOLD TO WIDTH (MTW) SPROCKET POSITION

- Tracking tabs on MTW belts provide positive lateral tracking. These tabs run in tracks by spacing wearstrips 1.75 in (44.5 mm) apart.

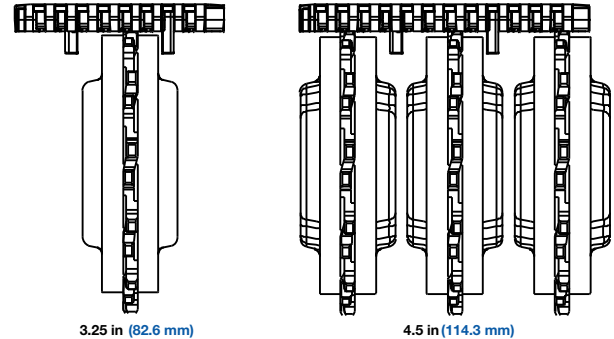

Figure 115: Sprocket tracking tabs

- If tabs are not used to track the belt, fix the center sprocket in the center of the belt.
- For S900 MTW 3.25 in (83 mm) and 4.5 in (114.3 mm) the center sprocket is 0.16 in (4 mm) off center.

SERIES 900-2

BELTS COVERED IN SECTION

- Open Flush Grid

NOTE: Before use in food-safe applications, follow good manufacturing practice and thoroughly clean and sanitize belts according to your standard sanitary operating procedures.

NYLON ROD OVERVIEW

S900 Open Flush Grid belts are designed to accommodate nylon rod growth for belts up to 42 in (1067 mm) wide. The rod end changes location in the flush edge area as growth occurs.

- When a dry nylon rod is pushed to one side of the belt, the other end of the rod moves slightly inside the flush edge on the other side of the belt.



Figure 116: Rods move inside flush edge

- As a nylon rod grows, the rod moves out to fill up the flush edge on both sides of the belt. The rod growth depends on the belt width and amount of water the rod absorbs.



Figure 117: Rod grows into flush edge

UNHEADED ROD

- Ensure rods are the correct length.
- Whenever possible, use the precut rods supplied with the belt. If precut rods are not available, ensure dry nylon rods are cut 1.40 ± 0.05 in (35.7 mm) shorter than the overall belt width.
- Because wet nylon rods shrink as they dry, do not cut wet nylon rods to length.

- Cut polypropylene or acetal rods 0.60 ± 0.05 in (15.2 mm) shorter than the overall belt width.

DETERMINE TOP AND BOTTOM

Ensure the belt is installed with the top surface facing up. Use the following figures to identify the belt top and bottom.

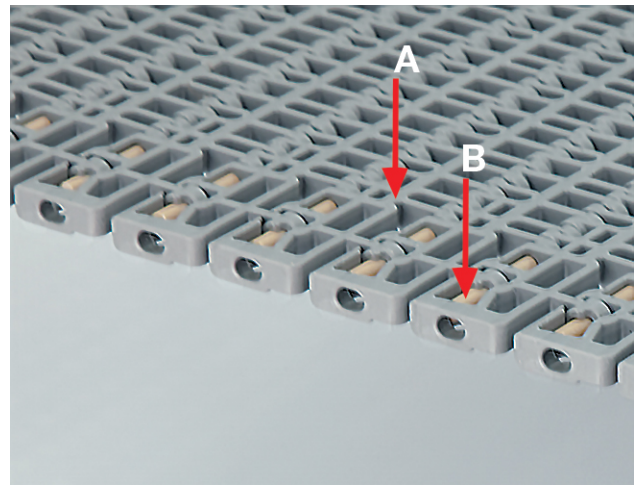

- A** flush surface
- B** accessible rod

Figure 118: S900 Open Flush Grid belt top

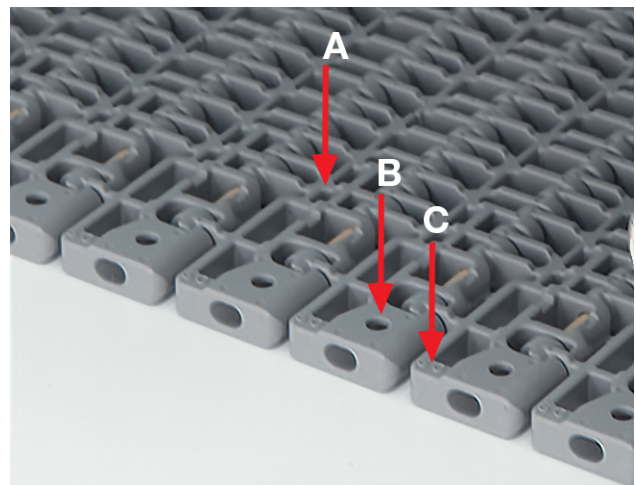

- A** surface not flush
- B** rod end shielded
- C** number

Figure 119: S900 Open Flush Grid belt bottom

CONNECT RODLESS LINKS

The rodless link on each side of the belt must be properly connected before inserting the rod.

SERIES 900-2

NOTE: 6.0 in and 6.3 in flush edge modules cannot be joined on the same belt edge. Each belt edge **MUST** be all 6.0 in or 6.3 in flush edge modules.

1. Lift and move the rodless link so it sits above the link pocket on the next module.

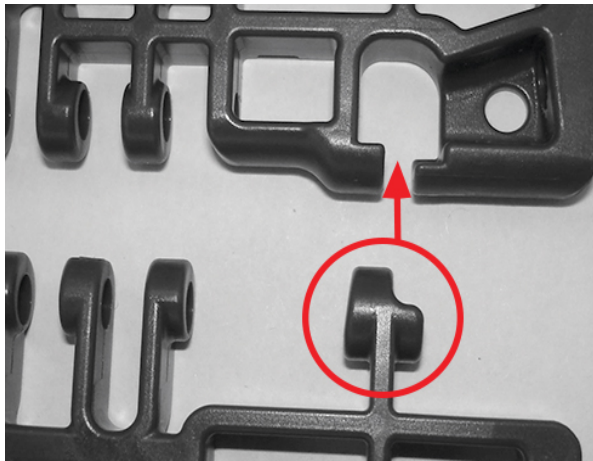

A Rodless link

Figure 120: Move rodless link into link pocket

2. Press the rodless link down so it sits securely in the link pocket.
3. Slowly release the link to allow belt tension to hold the rodless link. Under normal tension, the rodless link holds the belt together until a rod is properly inserted.

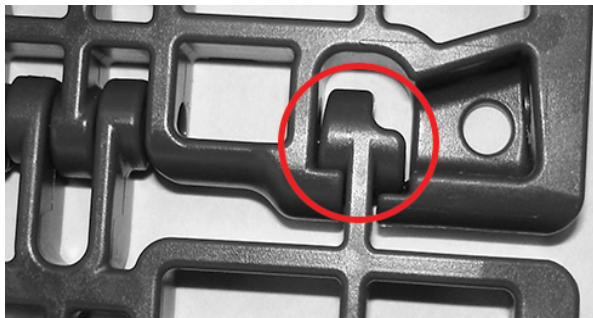

A Rodless link

Figure 121: Link properly positioned

INSERT THE ROD

1. Ensure the rodless links are connected. See [Connect Rodless Links](#) for information.

2. Insert the rod through the hinges as far as possible.

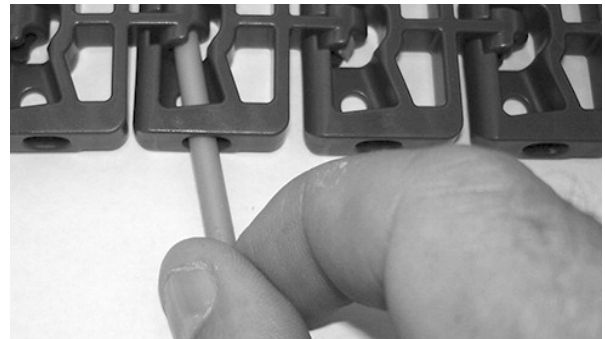

Figure 122: Insert rod through hinges

3. Use a screwdriver to push the rod past the retention feature.



Figure 123: Push rod past retention feature

4. Ensure the rod is fully inserted.

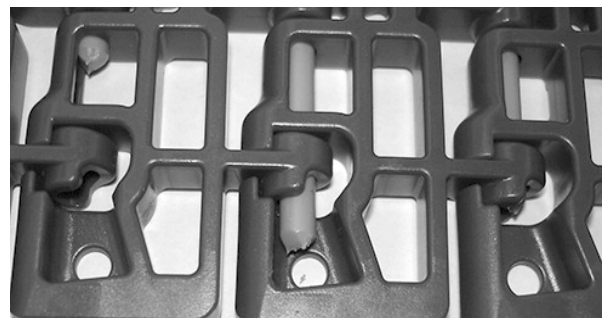

Figure 124: Ensure rod is fully inserted

REMOVE THE ROD

1. From the top of the belt, insert a screwdriver between the rod and the belt.

- Twist the screwdriver to bend and push the rod through the retention feature and out of the belt.



A Retention feature
Figure 125: Push rod past retention feature

- Once past the belt edge, pull the rod out to open the belt.



Figure 126: Pull rod from belt

- Lift the rodless link out of the link pocket to open the belt.

LOCKED SPROCKET LOCATION

NOTE: For center sprocket offsets marked with an asterisk (*), ensure the 6.3 in flush edge module is on the left belt edge in the preferred run direction before determining the locked sprocket location.

Link Count	Nominal Belt Width		Center From Edge		Center Sprocket Offset
	in	mm	in	mm	
36	12	304.8	6	152.4	0.5 in (12.7 mm)
37	12.3	313.3	6.2	156.6	0.35 in (8.9 mm) to the left*
38	12.7	321.7	6.3	160.9	0.5 in (12.7 mm)
39	13	330.2	6.5	165.1	0
40	13.3	338.7	6.7	169.3	0.85 in (21.6 mm) to the left*
41	13.7	347.1	6.8	173.6	0
42	14	355.6	7	177.8	0.5 in (12.7 mm)
43	14.3	364.1	7.2	182	0.35 in (8.9 mm) to the left*
44	14.7	372.5	7.3	186.3	0.5 in (12.7 mm)
45	15	381	7.5	190.5	0
46	15.3	389.5	7.7	194.7	0.85 in (21.6 mm) to the left*
47	15.7	397.9	7.8	199	0
48	16	406.4	8	203.2	0.5 in (12.7 mm)
49	16.3	414.9	8.2	207.4	0.35 in (8.9 mm) to the left*
50	16.7	423.3	8.3	211.7	0.5 in (12.7 mm)
51	17	431.8	8.5	215.9	0
52	17.3	440.3	8.7	220.1	0.85 in (21.6 mm) to the left*
53	17.7	448.7	8.8	224.4	0
54	18	457.2	9	228.6	0.5 in (12.7 mm)
55	18.3	465.7	9.2	232.8	0.35 in (8.9 mm) to the left*
56	18.7	474.1	9.3	237.1	0.5 in (12.7 mm)
57	19.0	482.6	9.5	241.3	0
58	19.3	491.1	9.7	245.5	0.85 in (21.6 mm) to the left*
59	19.7	499.5	9.8	249.8	0
60	20	508	10	254	0.5 in (12.7 mm)
61	20.3	516.5	10.2	258.2	0.35 in (8.9 mm) to the left*
62	20.7	524.9	10.3	262.5	0.5 in (12.7 mm)

SERIES 900-2

Link Count	Nominal Belt Width		Center From Edge		Center Sprocket Offset
	in	mm	in	mm	
63	21.0	533.4	10.5	266.7	0
64	21.3	541.9	10.7	270.9	0.85 in (21.6 mm) to the left*
65	21.7	550.3	10.8	275.2	0
66	22.0	558.8	11.0	279.4	0.5 in (12.7 mm)
67	22.3	567.3	11.2	283.6	0.35 in (8.9 mm) to the left*
68	22.7	575.7	11.3	287.9	0.5 in (12.7 mm)
69	23.0	584.2	11.5	292.1	0
70	23.3	592.7	11.7	296.3	0.85 in (21.6 mm) to the left*
71	23.7	601.1	11.8	300.6	0
72	24.0	609.6	12.0	304.8	0.5 in (12.7 mm)
73	24.3	618.1	12.2	309.0	0.35 in (8.9 mm) to the left*
74	24.7	626.5	12.3	313.3	0.5 in (12.7 mm)
75	25.0	635.0	12.5	317.5	0
76	25.3	643.5	12.7	321.7	0.85 in (21.6 mm) to the left*
77	25.7	651.9	12.8	326.0	0
78	26.0	660.4	13.0	330.2	0.5 in (12.7 mm)
79	26.3	668.9	13.2	334.4	0.35 in (8.9 mm) to the left*
80	26.7	677.3	13.3	338.7	0.5 in (12.7 mm)
81	27.0	685.8	13.5	342.9	0
82	27.3	694.3	13.7	347.1	0.85 in (21.6 mm) to the left*
83	27.7	702.7	13.8	351.4	0
84	28.0	711.2	14.0	355.6	0.5 in (12.7 mm)
85	28.3	719.7	14.2	359.8	0.35 in (8.9 mm) to the left*
86	28.7	728.1	14.3	364.1	0.5 in (12.7 mm)
87	29.0	736.6	14.5	368.3	0
88	29.3	745.1	14.7	372.5	0.85 in (21.6 mm) to the left*
89	29.7	753.5	14.8	376.8	0
90	30.0	762.0	15.0	381.0	0.5 in (12.7 mm)
91	30.3	770.5	15.2	385.2	0.35 in (8.9 mm) to the left*
92	30.7	778.9	15.3	389.5	0.5 in (12.7 mm)
93	31.0	787.4	15.5	393.7	0
94	31.3	795.9	15.7	397.9	0.85 in (21.6 mm) to the left*

Link Count	Nominal Belt Width		Center From Edge		Center Sprocket Offset
	in	mm	in	mm	
95	31.7	804.3	15.8	402.2	0
96	32.0	812.8	16.0	406.4	0.5 in (12.7 mm)
97	32.3	821.3	16.2	410.6	0.35 in (8.9 mm) to the left*
98	32.7	829.7	16.3	414.9	0.5 in (12.7 mm)
99	33.0	838.2	16.5	419.1	0
100	33.3	846.7	16.7	423.3	0.85 in (21.6 mm) to the left*
101	33.7	855.1	16.8	427.6	0
102	34.0	863.6	17.0	431.8	0.5 in (12.7 mm)
103	34.3	872.1	17.2	436.0	0.35 in (8.9 mm) to the left*
104	34.7	880.5	17.3	440.3	0.5 in (12.7 mm)
105	35.0	889.0	17.5	444.5	0
106	35.3	897.5	17.7	448.7	0.85 in (21.6 mm) to the left*
107	35.7	905.9	17.8	453.0	0
108	36.0	914.4	18.0	457.2	0.5 in (12.7 mm)
109	36.3	922.9	18.2	461.4	0.35 in (8.9 mm) to the left*
110	36.7	931.3	18.3	465.7	0.5 in (12.7 mm)
111	37.0	939.8	18.5	469.9	0
112	37.3	948.3	18.7	474.1	0.85 in (21.6 mm) to the left*
113	37.7	956.7	18.8	478.4	0
114	38.0	965.2	19.0	482.6	0.5 in (12.7 mm)
115	38.3	973.7	19.2	486.8	0.35 in (8.9 mm) to the left*
116	38.7	982.1	19.3	491.1	0.5 in (12.7 mm)
117	39.0	990.6	19.5	495.3	0
118	39.3	999.1	19.7	499.5	0.85 in (21.6 mm) to the left*
119	39.7	1007.5	19.8	503.8	0
120	40.0	1016.0	20.0	508.0	0.5 in (12.7 mm)
121	40.3	1024.5	20.2	512.2	0.35 in (8.9 mm) to the left*
122	40.7	1032.9	20.3	516.5	0.5 in (12.7 mm)
123	41.0	1041.4	20.5	520.7	0
124	41.3	1049.9	20.7	524.9	0.85 in (21.6 mm) to the left*
125	41.7	1058.3	20.8	529.2	0
126	42.0	1066.8	21.0	533.4	0.5 in (12.7 mm)

Link Count	Nominal Belt Width		Center From Edge		Center Sprocket Offset
	in	mm	in	mm	
127	42.3	1075.3	21.2	537.6	0.35 in (8.9 mm) to the left*
128	42.7	1083.7	21.3	541.9	0.5 in (12.7 mm)
129	43.0	1092.2	21.5	546.1	0
130	43.3	1100.7	21.7	550.3	0.85 in (21.6 mm) to the left*
131	43.7	1109.1	21.8	554.6	0
132	44.0	1117.6	22.0	558.8	0.5 in (12.7 mm)
133	44.3	1126.1	22.2	563.0	0.35 in (8.9 mm) to the left*
134	44.7	1134.5	22.3	567.3	0.5 in (12.7 mm)
135	45.0	1143.0	22.5	571.5	0
136	45.3	1151.5	22.7	575.7	0.85 in (21.6 mm) to the left*
137	45.7	1159.9	22.8	580.0	0
138	46.0	1168.4	23.0	584.2	0.5 in (12.7 mm)
139	46.3	1176.9	23.2	588.4	0.35 in (8.9 mm) to the left*
140	46.7	1185.3	23.3	592.7	0.5 in (12.7 mm)
141	47.0	1193.8	23.5	596.9	0
142	47.3	1202.3	23.7	601.1	0.85 in (21.6 mm) to the left*
143	47.7	1210.7	23.8	605.4	0
144	48.0	1219.2	24.0	609.6	0.5 in (12.7 mm)
145	48.3	1227.7	24.2	613.8	0.35 in (8.9 mm) to the left*
146	48.7	1236.1	24.3	618.1	0.5 in (12.7 mm)
147	49.0	1244.6	24.5	622.3	0
148	49.3	1253.1	24.7	626.5	0.85 in (21.6 mm) to the left*
149	49.7	1261.5	24.8	630.8	0
150	50.0	1270.0	25.0	635.0	0.5 in (12.7 mm)
151	50.3	1278.5	25.2	639.2	0.35 in (8.9 mm) to the left*
152	50.7	1286.9	25.3	643.5	0.5 in (12.7 mm)
153	51.0	1295.4	25.5	647.7	0
154	51.3	1303.9	25.7	651.9	0.85 in (21.6 mm) to the left*
155	51.7	1312.3	25.8	656.2	0
156	52.0	1320.8	26.0	660.4	0.5 in (12.7 mm)
157	52.3	1329.3	26.2	664.6	0.35 in (8.9 mm) to the left*
158	52.7	1337.7	26.3	668.9	0.5 in (12.7 mm)

Link Count	Nominal Belt Width		Center From Edge		Center Sprocket Offset
	in	mm	in	mm	
159	53.0	1346.2	26.5	673.1	0
160	53.3	1354.7	26.7	677.3	0.85 in (21.6 mm) to the left*
161	53.7	1363.1	26.8	681.6	0
162	54.0	1371.6	27.0	685.8	0.5 in (12.7 mm)
163	54.3	1380.1	27.2	690.0	0.35 in (8.9 mm) to the left*
164	54.7	1388.5	27.3	694.3	0.5 in (12.7 mm)
165	55.0	1397.0	27.5	698.5	0
166	55.3	1405.5	27.7	702.7	0.85 in (21.6 mm) to the left*
167	55.7	1413.9	27.8	707.0	0
168	56.0	1422.4	28.0	711.2	0.5 in (12.7 mm)
169	56.3	1430.9	28.2	715.4	0.35 in (8.9 mm) to the left*
170	56.7	1439.3	28.3	719.7	0.5 in (12.7 mm)
171	57.0	1447.8	28.5	723.9	0
172	57.3	1456.3	28.7	728.1	0.85 in (21.6 mm) to the left*
173	57.7	1464.7	28.8	732.4	0
174	58.0	1473.2	29.0	736.6	0.5 in (12.7 mm)
175	58.3	1481.7	29.2	740.8	0.35 in (8.9 mm) to the left*
176	58.7	1490.1	29.3	745.1	0.5 in (12.7 mm)
177	59.0	1498.6	29.5	749.3	0
178	59.3	1507.1	29.7	753.5	0.85 in (21.6 mm) to the left*
179	59.7	1515.5	29.8	757.8	0
180	60.0	1524.0	30.0	762.0	0.5 in (12.7 mm)
181	60.3	1532.5	30.2	766.2	0.35 in (8.9 mm) to the left*
182	60.7	1540.9	30.3	770.5	0.5 in (12.7 mm)
183	61.0	1549.4	30.5	774.7	0
184	61.3	1557.9	30.7	778.9	0.85 in (21.6 mm) to the left*
185	61.7	1566.3	30.8	783.2	0
186	62.0	1574.8	31.0	787.4	0.5 in (12.7 mm)

*Ensure the 6.3 in flush edge module is on the left belt edge in the preferred run direction before determining the locked sprocket location.

SERIES 1000-1

BELTS COVERED IN SECTION

- Flat Friction Top
- Flat Friction Top 85 mm
- Flat Top
- Flat Top 85 mm
- Insert Roller
- High Density Insert Roller
- High Density Roller 85 mm
- Non Skid Raised Rib

NOTE: Before use in food-safe applications, follow good manufacturing practice and thoroughly clean and sanitize belts according to your standard sanitary operating procedures.

UNHEADED ROD

- S1000 belts contain one closed edge and one open edge. Rods must be inserted in the open belt edge.
- Ensure rods are the correct length.
- Whenever possible, use the precut rods supplied with the belt.
- Because wet nylon rods shrink as they dry, do not cut wet nylon rods to length.

INSERT THE ROD

1. Cut rods shorter than the overall belt width.
2. Join belt ends together so the hinges are aligned.
3. Insert the rod through the hinges as far as possible.



Figure 127: Insert rod through hinge

4. Use a screwdriver to push the rod past the retention feature.

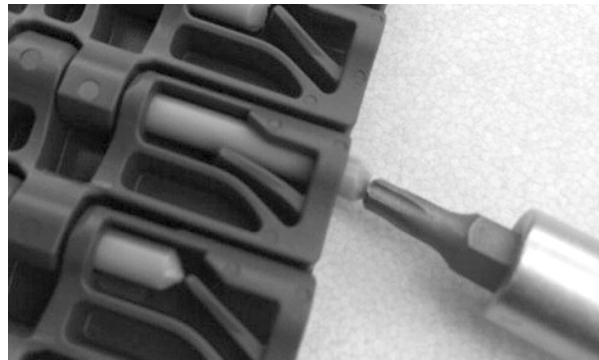

Figure 128: Push rod past retention feature

5. Ensure the rod is fully inserted.

REMOVE THE ROD

1. On the open belt edge, use a screwdriver or rod to push the retention feature open.

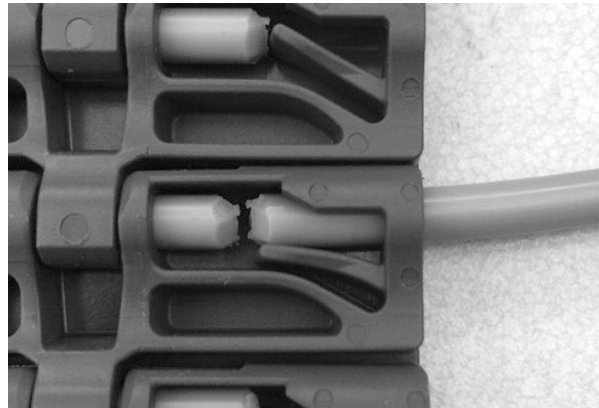

Figure 129: Push retention feature open

2. On the closed belt edge, use a small screwdriver or wire to push the rod past the belt edge.

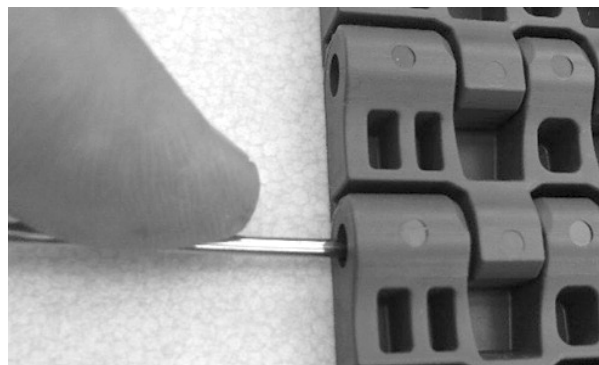

Figure 130: Push rod past belt edge

3. Once past the belt edge, pull the rod out to open the belt.

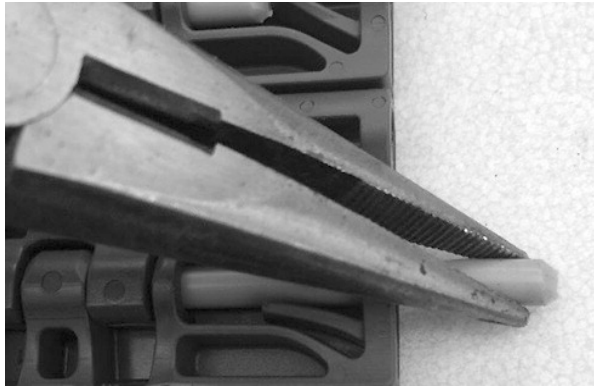

Figure 131: Pull rod from belt

SERIES 1000-2

BELTS COVERED IN SECTION

- Mold to Width Transfer Edge
- Mold to Width Flat Top
- Mold to Width Flat Friction Top

NOTE: Before use in food-safe applications, follow good manufacturing practice and thoroughly clean and sanitize belts according to your standard sanitary operating procedures.

PREFORMED HEADED ROD

INSERT THE ROD

1. Join belt ends together so the hinges are aligned.
2. Insert the rod through the hinges until the rod head touches the belt edge.
3. Use a screwdriver to push the rod head into the belt while applying pressure down and away from the Snap-Lock.

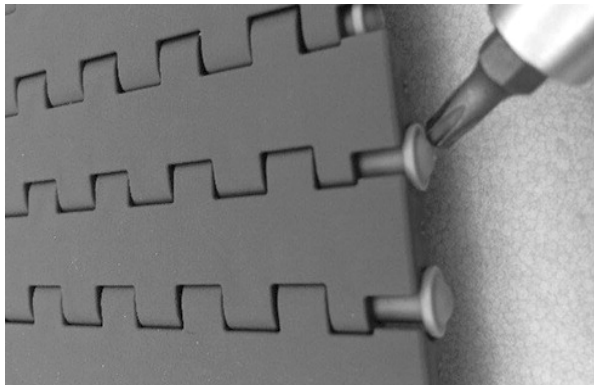

Figure 132: Push rod past retention feature

4. Once properly inserted, cut the opposite end of the rod flush with the belt edge.

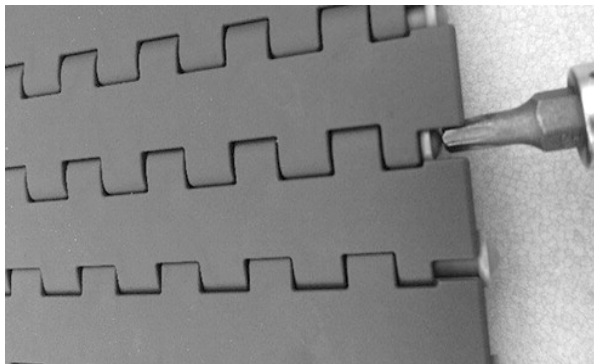

Figure 133: Cut opposite end of rod

REMOVE THE ROD

1. From the bottom of the belt, cut off the rod heads.

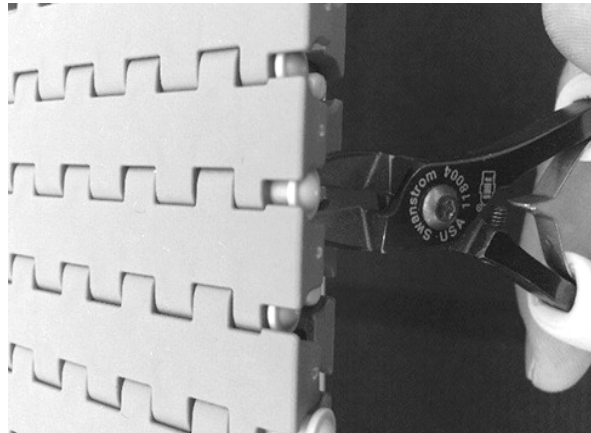

Figure 134: Cut rod head

2. Use a screwdriver to push the rod out of the belt.

SERIES 1100-1

BELTS COVERED IN SECTION

- 38 mm & 46 mm Wide
- Cone Top™
- Embedded Diamond Top
- Flush Grid
- Flush Grid Friction Top
- Flush Grid Friction Top No Indent
- Flush Grid Mold to Width
- Flush Grid Nub Top™
- ONEPIECE™ Live Transfer Flush Grid

NOTE: Before use in food-safe applications, follow good manufacturing practice and thoroughly clean and sanitize belts according to your standard sanitary operating procedures.

UNHEADED ROD

INSERT THE ROD

1. Cut rods 0.3 in (8 mm) shorter than the overall belt width.
2. Join belt ends together so the hinges are aligned.
3. Insert the rod through the hinges as far as possible.



Figure 135: Insert rod through hinges

4. Use a screwdriver to push the rod past the retention feature.

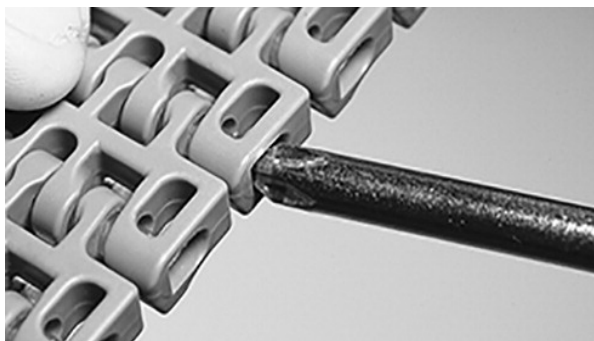

Figure 136: Push rod past retention feature

5. Ensure the rod is fully inserted.

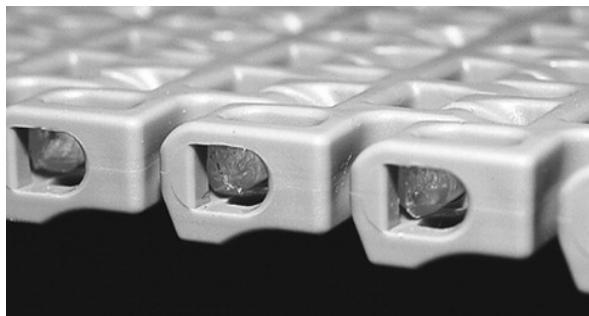

Figure 137: Ensure rod is past retention feature

REMOVE THE ROD

1. Insert a screwdriver between two flush edges.
2. Twist the screwdriver to bend and push the rod through the retention feature and out of the belt.

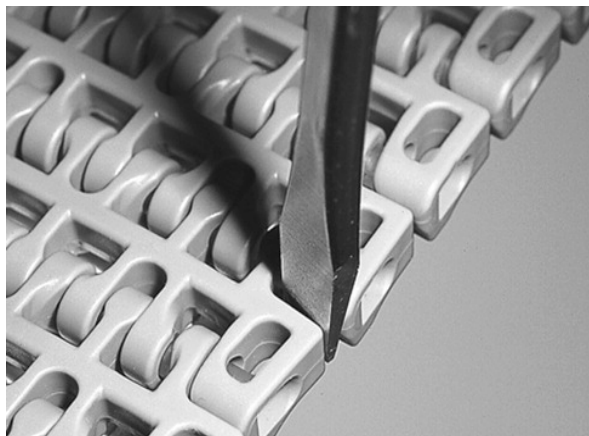

Figure 138: Push rod past retention feature

3. Use a screwdriver to push the rod out from the opposite belt edge.

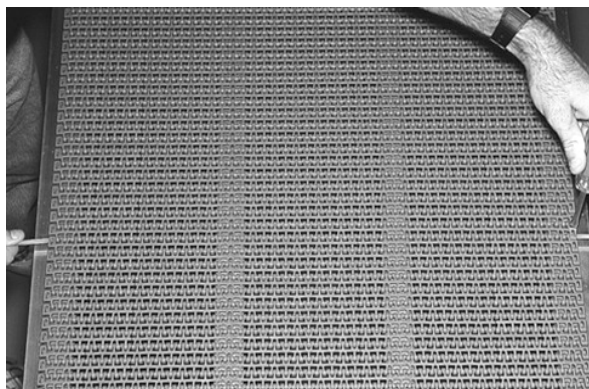

Figure 139: Push rod from belt

SPLICING ORIGINAL EDGE (VERSION 1) WITH NEW EDGE (VERSION 3)

1. Get two headed rods of the same material as the existing installed rods. Contact Intralox Customer Service for headed rods.
2. Cut the new 18 in (4.6 mm) diameter headed rods 0.25 in (6 mm) shorter than the belt width.
3. Bring the two belt ends close together, but do not join them.
4. On the old belt (Version 1), locate the flexible edge member that points toward the edge member on the new belt (Version 3).
5. Cut off half of the flexible edge member on the old belt.



Figure 140: Cut off half of edge

6. Repeat Steps 4 & 5 on the opposite belt edge.
7. Join belt ends together so the hinges are aligned.
8. Insert one of the pre-cut, headed rods into the belt from the side opposite the newly cut, flexible edge member (side B).
9. Use a screwdriver to push the rod head past the edge of the older module.

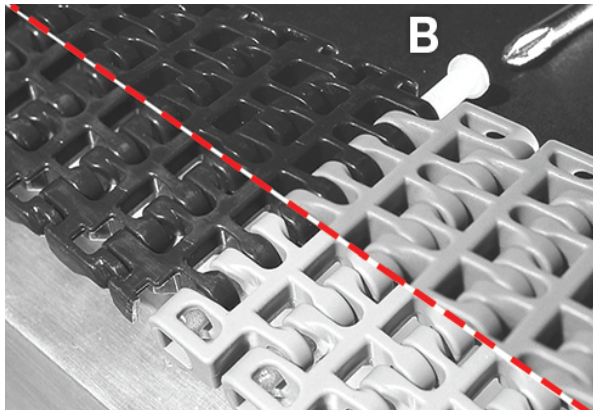

B Older module

Figure 141: Push rod past older module edge

SPLICING OLD EDGE (VERSION 2) WITH NEW EDGE (VERSION 3)

1. Get two unheaded rods of the same material as the existing installed rods.
2. Cut the new 0.18 in (4.6 mm) diameter rods 0.3 in (8 mm) shorter than the belt width.
3. Bring the two belt ends close together, but do not join them.
4. Cut off the lip on the old belt (Version 2).



Figure 142: Cut edge from belt

5. Join belt ends together so the hinges are aligned.
6. Insert one of the pre-cut, unheaded rods as far as possible.
7. Use a screwdriver to push the rod past the retention feature.

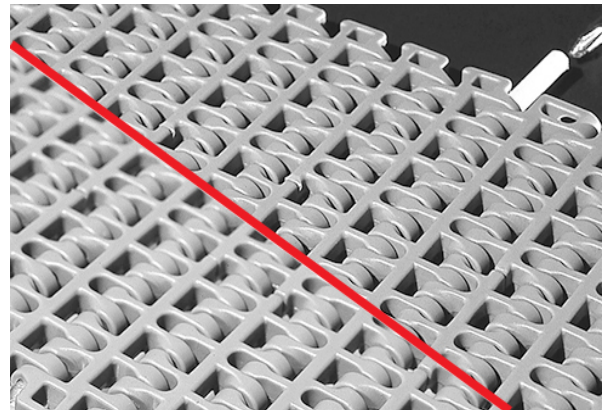

Figure 143: Push rod past retention feature

SERIES 1100-2

BELTS COVERED IN SECTION

- Flat Top
- Perforated Flat Top

NOTE: Before use in food-safe applications, follow good manufacturing practice and thoroughly clean and sanitize belts according to your standard sanitary operating procedures.

UNHEADED ROD

INSERT THE ROD

1. Cut rods 0.3 in (8 mm) shorter than the overall belt width.
2. Join belt ends together so the hinges are aligned.
3. Insert the rod through the hinges as far as possible.



Figure 144: Insert rod through hinges

4. Use a screwdriver to push the rod past the retention feature.

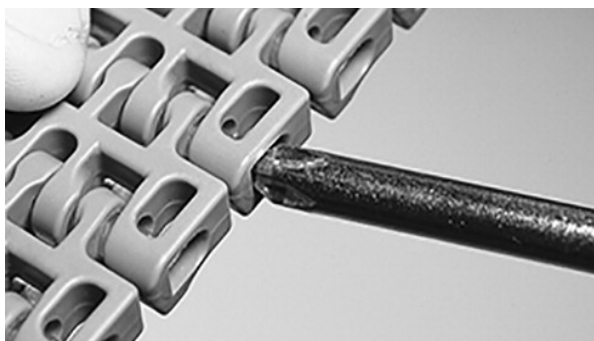

Figure 145: Push rod past retention feature

5. Ensure the rod is fully inserted.

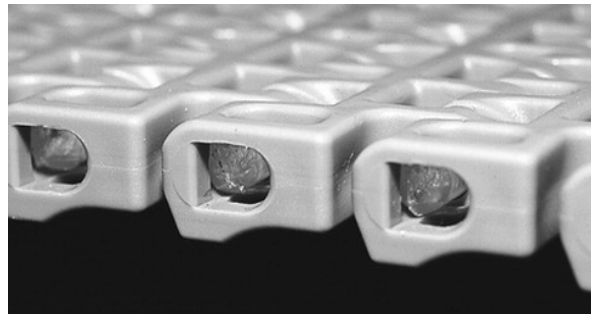

Figure 146: Ensure rod is past retention feature

REMOVE THE ROD

1. On the bottom of the belt, grip the rod in the opening near the belt edge.

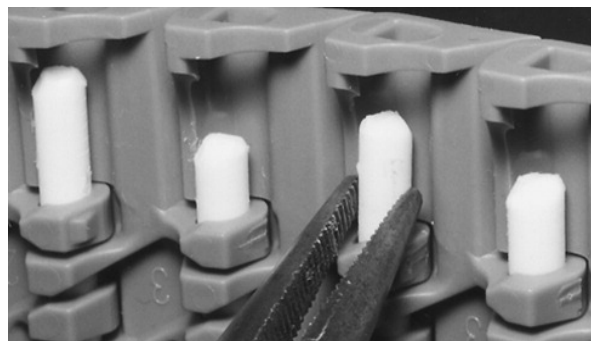

Figure 147: Grip rod

2. Push the rod slightly to the side and past the retention feature.

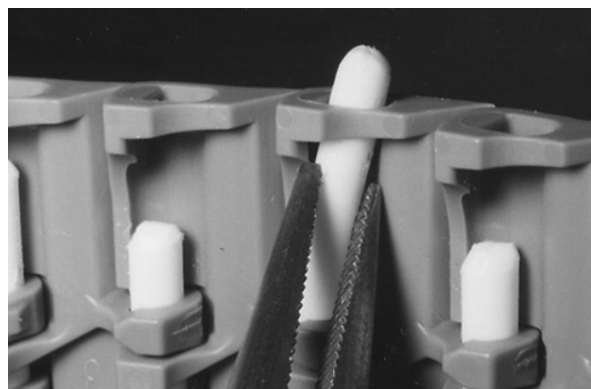

Figure 148: Push rod past retention feature

- Once past the belt edge, pull the rod out to open the belt.

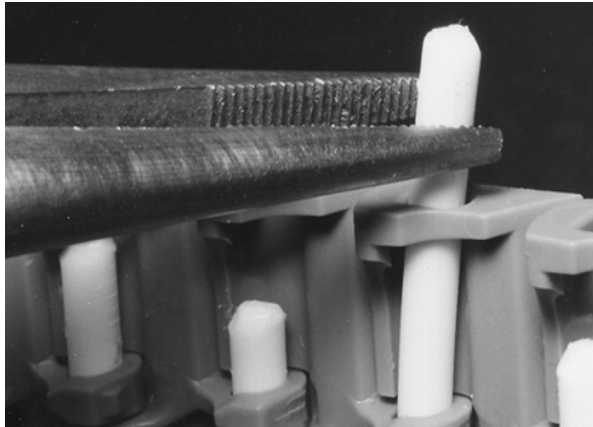

Figure 149: Pull rod from belt

SPLICING ORIGINAL EDGE (VERSION 1) WITH NEW EDGE (VERSION 3)

- Get two headed rods of the same material as the existing installed rods. Contact Intralox Customer Service for headed rods.
- Cut the new 18 in (4.6 mm) diameter headed rods 0.25 in (6 mm) shorter than the belt width.
- Bring the two belt ends close together, but do not join them.
- On the old belt (Version 1), locate the flexible edge member that points toward the edge member on the new belt (Version 3).
- Cut off half of the flexible edge member on the old belt.



Figure 150: Cut edge member

- Repeat Steps 4 & 5 on the opposite belt edge.
- Join belt ends together so the hinges are aligned.
- Insert one of the pre-cut, headed rods into the belt from the side opposite the newly cut, flexible edge member (side B).

- Use a screwdriver to push the rod head past the edge of the older module.

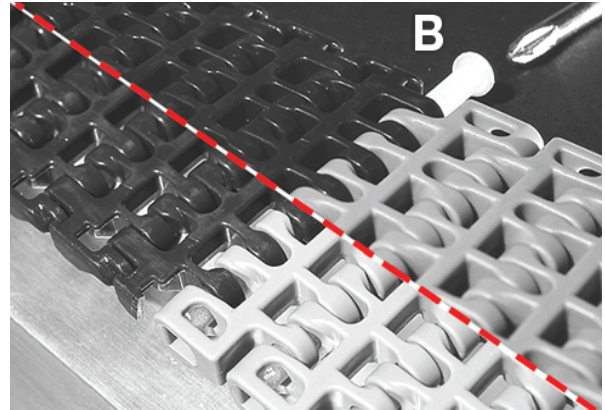

B Retention feature

Figure 151: Push rod past retention feature

SPLICING OLD EDGE (VERSION 2) WITH NEW EDGE (VERSION 3)

- Get two unheaded rods of the same material as the existing installed rods.
- Cut the new 0.18 in (4.6 mm) diameter rods 0.3 in (8 mm) shorter than the belt width.
- Bring the two belt ends close together, but do not join them.
- Cut off the lip on the old belt (Version 2).



Figure 152: Cut edge from belt

- Join belt ends together so the hinges are aligned.
- Insert one of the pre-cut, unheaded rods as far as possible.

7. Use a screwdriver to push the rod past the retention feature.

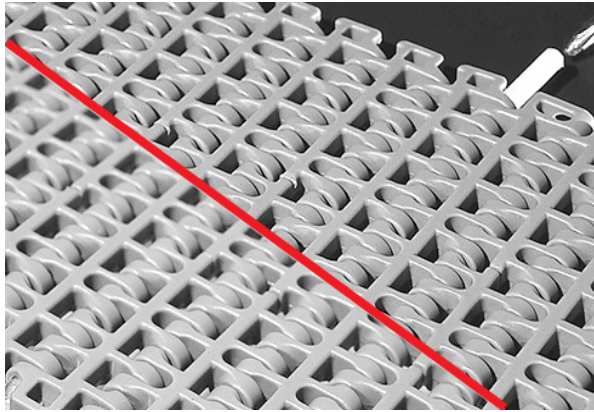

Figure 153: Push rod past retention feature

SERIES 1200-1

BELTS COVERED IN SECTION

- Flat Top
- Flush Grid
- Non Skid
- Non Skid Raised Rib
- Raised Rib

NOTE: Before use in food-safe applications, follow good manufacturing practice and thoroughly clean and sanitize belts according to your standard sanitary operating procedures.

BELT RUN DIRECTION

- S1200 belts have a preferred run direction. When run in this direction, the belt can pull the maximum load.
- The preferred direction is indicated by the run direction arrow molded into the underside of the edge modules.
- If the run direction arrow wears off, the preferred drive surface is the side with a link molded to it. The increased support of this link makes the belt stronger in this direction.
- On bi-directional conveyors, the preferred direction should coincide with the direction the belt runs most frequently. If the belt is run in the non-preferred direction, the load rating is 2,000 lb/ft (3000 kg/m).



Figure 154: Belt running direction

UNHEADED ROD AND SLIDELOX RETAINER

INSERT THE ROD

1. On one belt edge, ensure the Slidelox is closed. If not, use a screwdriver to slide the latch to close the Slidelox.
2. On the opposite belt edge, ensure the Slidelox is open. If not, use a screwdriver to slide the latch to open the Slidelox.

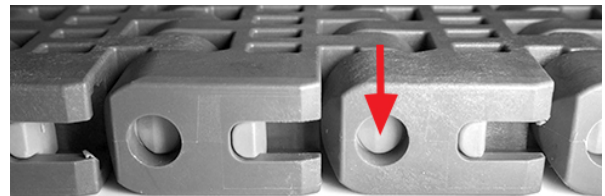

Figure 155: Ensure Slidelox is open

3. Join belt ends together so the hinges are aligned.
4. Insert the rod through the open Slidelox.
5. Once the rod is inserted, close the Slidelox. The Slidelox snaps when closed.

NOTE: Ensure ALL Slidelox are closed after installation.

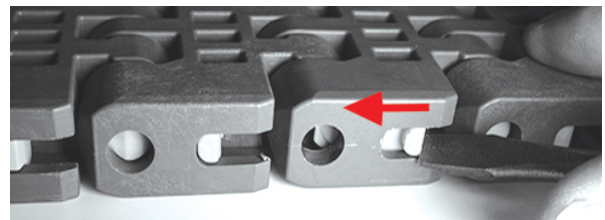

Figure 156: Close Slidelox

REMOVE THE ROD

NOTE: DO NOT remove Slidelox from edge modules. Removal can destroy the Slidelox and module.

1. Use a screwdriver to open the Slidelox on both belt edges.

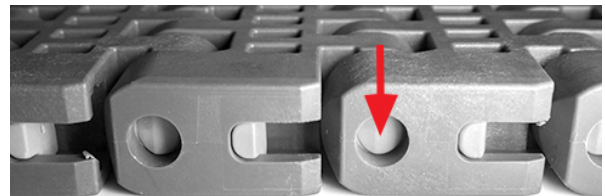

Figure 157: Open Slidelox

2. Use a screwdriver to push the rod out of the belt.

SERIES 1200-1

- Once the rod is removed, slide the latch to close the Slidelox. The Slidelox snaps when closed.

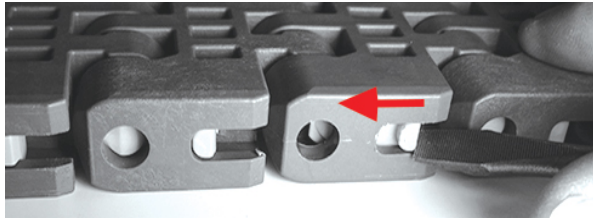

Figure 158: Close Slidelox

NOTE: Ensure ALL Slidelox are closed after installation.

LOCKED SPROCKET LOCATION

- S1200 sprockets engage into dedicated pockets on the underside of the belt located every 2 in (50.8 mm) across the belt width.
- Belt load determines sprocket spacing. Normally, the spacing is 4 in (101.6 mm) or 6 in (152.4 mm). Sprocket spacing is always a multiple of 2 in (50.8 mm), with 2 in (50.8 mm) being the closest spacing possible.
- Lock the centermost sprocket in place to retain the belt laterally. On large, heavily loaded conveyors, such as pasteurizers, locking the sprocket is best accomplished with a custom-designed locking collar. Avoid stress concentrations in the shaft due to machining.
- Use the belt width to determine the locked sprocket location. The sprocket pocket closest to the center of the belt (the recommended location for the locked sprocket) is determined using the following table. All references are from the right-hand side of the belt (when viewed from the belt run direction).

Nominal Belt Width Range		Distance From Right Edge	
in	mm	in	mm
6-9	152-229	2.83	71.9
10-13	254-330	4.83	122.7
14-17	356-432	6.83	173.5
18-21	457-533	8.83	224.3
22-25	559-635	10.83	275.1
26-29	660-737	12.83	325.9
30-33	762-838	14.83	376.7
34-37	864-940	16.83	427.5
38-41	965-1041	18.83	478.3
42-45	1067-1143	20.83	529.1

Nominal Belt Width Range		Distance From Right Edge	
in	mm	in	mm
46-49	1168-1245	22.83	579.9
50-53	1270-1346	24.83	630.7
54-57	1372-1448	26.83	681.5
58-61	1473-1549	28.83	732.3
62-65	1575-1651	30.83	783.1
66-69	1676-1753	32.83	833.9
70-73	1778-1854	34.83	884.7
74-77	1880-1956	36.83	935.5
78-81	1981-2057	38.83	986.3
82-85	2083-2159	40.83	1037.1
86-89	2184-2261	42.83	1087.9
90-93	2286-2362	44.83	1138.7
94-97	2388-2464	46.83	1189.5
98-101	2489-2565	48.83	1240.3
102-105	2591-2667	50.83	1291.1
106-109	2692-2769	52.83	1341.9
110-113	2794-2870	54.83	1392.7
114-117	2896-2972	56.83	1443.5
118-121	2997-3073	58.83	1494.3
122-125	3099-3175	60.83	1545.1
126-129	3200-3277	62.83	1595.9
130-133	3302-3378	64.83	1646.7
134-137	3404-3480	66.83	1697.5
138-141	3505-3581	68.83	1748.3
142-145	3607-3683	70.83	1799.1
146-149	3708-3785	72.83	1849.9
150-153	3810-3886	74.83	1900.7
154-157	3912-3988	76.83	1951.5
158-161	4013-4089	78.83	2002.3
162-165	4115-4191	80.83	2053.1
166-169	4216-4293	82.83	2103.9
170-173	4318-4394	84.83	2154.7
174-177	4420-4496	86.83	2205.5
178-181	4521-4597	88.83	2256.3
182-185	4623-4699	90.83	2307.1
186-189	4724-4801	92.83	2357.9
190-193	4826-4902	94.83	2408.7
194-197	4928-5004	96.83	2459.5
198-201	5029-5105	98.83	2501.3
202-205	5131-5207	100.83	2561.1
206-209	5232-5309	102.83	2611.9

Nominal Belt Width Range		Distance From Right Edge	
in	mm	in	mm
210–213	5334–5410	104.83	2662.7
214–217	5436–5512	106.83	2713.5
218–221	5537–5613	108.83	2764.3
222–225	5639–5715	110.83	2815.1
226–229	5740–5817	112.83	2865.9
230–233	5842–5918	114.83	2916.7
234–237	5944–6020	116.83	2967.5
238–241	6045–6121	118.83	3018.3
242–245	6147–6223	120.83	3069.1
246–249	6248–6325	122.83	3119.9
250–253	6350–6426	124.83	3170.7
254–257	6452–6528	126.83	3221.5
258–261	6553–6629	128.83	3272.3
262–265	6655–6731	130.83	3323.1
266–269	6756–6833	132.83	3373.9
270–273	6858–6934	134.83	3424.7
274–277	6960–7036	136.83	3475.5
278–281	7061–7137	138.83	3526.3
282–285	7163–7239	140.83	3577.1
286–288	7264–7315	142.83	3627.9

SERIES 1400-1

BELTS COVERED IN SECTION

- 3.25 in Mold to Width (MTW) Flat Friction Top with Tabs
- 6 in Flat Top Mold to Width (MTW) Self-Clearing Edge
- Embedded Diamond Top
- Flat Friction Top
- Flat Top
- Flat Top Easy Release PLUS
- Flat Top Easy Release Traceable Polypropylene
- Flush Grid
- Mold to Width (MTW) Flat Top
- Mold to Width (MTW) Oval Friction Top
- Mold to Width (MTW) Square Friction Top
- Non Skid
- ONEPIECE Live Transfer Flat Top
- ONEPIECE™ 9.3 in (236 mm) Live Transfer Flat Top
- Oval Friction Top
- ProTrax™ with Tabs
- Roller Top™
- Square Friction Top

NOTE: Before use in food-safe applications, follow good manufacturing practice and thoroughly clean and sanitize belts according to your standard sanitary operating procedures.

UNHEADED ROD AND SLIDELOX RETAINER

INSERT THE ROD

1. On one belt edge, ensure the Slidelox is closed. If not, use a screwdriver to slide the latch to close the Slidelox.

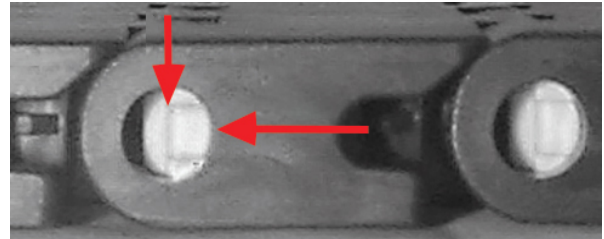

Figure 159: Slidelox in closed position



Figure 160: Use screwdriver to close Slidelox

2. On the opposite belt edge, ensure the Slidelox is open. If not, use a screwdriver to slide the latch to open the Slidelox.
3. Join belt ends together so the hinges are aligned.
4. Insert the rod through the open Slidelox.

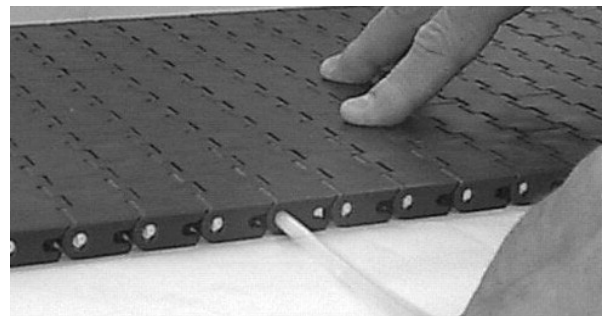

Figure 161: Insert rod

5. Ensure the rod is inserted about 0.5 in (12.7 mm) past the belt edge.

SERIES 1400-1

- Once the rod is inserted, close the Slidelox. The Slidelox snaps when closed.

NOTE: Ensure ALL Slidelox are closed after installation.



Figure 162: Close the Slidelox

REMOVE THE ROD

NOTE: DO NOT remove Slidelox from edge modules. Removal can destroy the Slidelox and module.

- Use a screwdriver to open the Slidelox on both belt edges.

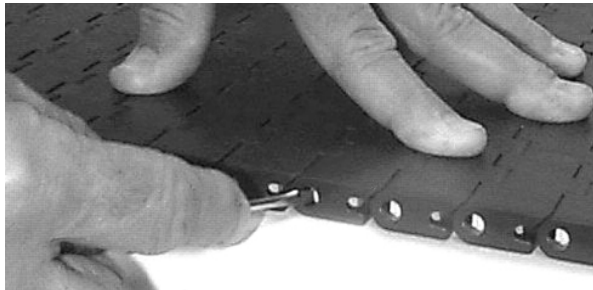

Figure 163: Open Slidelox

- Use a screwdriver to push the rod out of the belt.

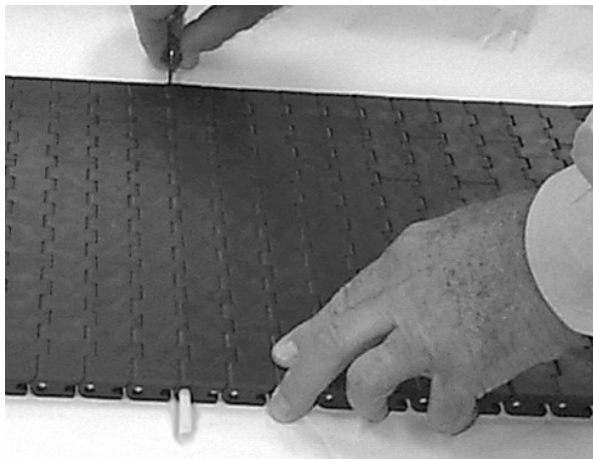

Figure 164: Push rod from belt

- Once the rod is removed, slide the latch to close the Slidelox. The Slidelox snaps when closed.

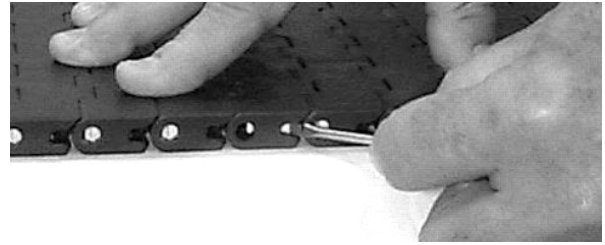

Figure 165: Close Slidelox

NOTE: Ensure ALL Slidelox are closed after installation.

MTW SPROCKET POSITION

- Tracking tabs on MTW belts provide positive lateral tracking. These tabs run in tracks by spacing wearstrips 1.75 in (44.5 mm) apart.

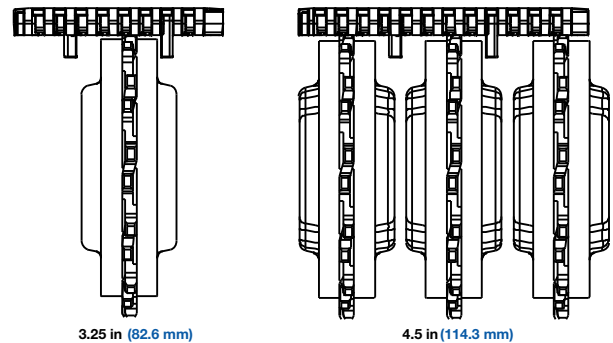

Figure 166: Sprocket tracking tabs

- If tabs are not used to track the belt, fix the center sprocket in the center of the belt.

LOCKED SPROCKET LOCATION

- S1400 Flush Grid sprockets engage with dedicated pockets on the underside of the belt located every 3 in (76.2 mm) across the belt width.
- Belt load determines sprocket spacing. Normally, the spacing is 3 in (76.2 mm) or 6 in (152.4 mm). Sprocket spacing is always in multiples of 3 in (76.2 mm) with 3 in (76.2 mm) being the closest spacing possible.
- Lock the centermost sprocket in place to retain the belt laterally.
- Use the belt width to determine the locked sprocket location. The sprocket pocket closest to the center of the belt (the recommended location for the locked sprocket) is determined using the following table. All references are from the right-hand side of the belt (when viewed from the belt run direction).

Location of the Center of the Locked Sprocket			
Nominal Belt Width Range		Distance From Right Edge	
in	mm	in	mm
9-10	229-254	4.42	112
11	279	5.42	138
12-13, 15-16	305-330, 381-406	7.42	188
14, 17	356, 432	8.42	214
18-19, 21-22	457-483, 533-559	10.42	265
20, 23	508, 548	11.42	290
24-25, 27-28	610-635, 686-711	13.42	341
26, 29	660, 737	14.42	366
30-31, 33-34	762-787, 838-864	16.42	417
32, 35	813, 889	17.42	442
36-37, 39-40	914-940, 991-1016	19.42	493
38.41	965, 1041	20.42	519
42-43, 45-46	1067-1092, 1143-1168	22.42	569
44, 47	1118, 1194	23.42	595
48-49, 51-52	1219-1245, 1295-1321	25.42	646
50, 53	1270, 1346	26.42	671
54-55, 57-58	1372-1397, 1448-1473	28.42	722
56, 59	1422, 1499	29.42	747
60-61, 63-64	1524-1549, 1600-1626	31.42	798
62, 65	1575, 1651	32.42	823

Location of the Center of the Locked Sprocket			
Nominal Belt Width Range		Distance From Right Edge	
in	mm	in	mm
66-67, 69-70	1676-1702, 1753-1778	34.42	874
68, 71	1727, 1803	35.42	900
72-73, 75-76	1829-1854, 1905-1930	37.42	950
74, 77	1880, 1956	38.42	976
78-79, 81-82	1981-2007, 2057-2083	40.42	1027
80, 83	2032, 2108	41.42	1052
84-85, 87-88	2134-2159, 2210-2235	43.42	1103
86, 89	2184, 2261	44.42	1128
90-91, 93-94	2286-2311, 2362-2388	46.42	1179
92, 95	2337, 2413	47.42	1204
96-97, 99-100	2438-2464, 2515-2540	49.42	1255
98, 101	2489, 2565	50.42	1281
102-103, 105-106	2591-2616, 2667-2692	52.42	1331
104, 107	2642, 2718	53.42	1357
108-109, 111-112	2743-2769, 2819-2845	55.42	1408
110, 113	2794, 2870	56.42	1433
114-115, 117-118	2896-2921, 2972-2997	58.42	1484
116-119	2946, 3023	59.42	1509
120-121, 123-124	3048-3073, 3142-3150	61.42	1560
122, 125	3099, 3175	62.42	1585
126-127, 129-130	3200-3226, 3277-3302	64.42	1636
128, 131	3251, 3327	65.42	1662
132-133, 135-136	3353-3378, 3429-3454	67.42	1712
134, 137	3404, 3480	68.42	1738
138-139, 141-142	3503-3531, 3581-3607	70.42	1789
140, 143	3556, 3632	71.42	1814
144-145, 147-148	3658-3683, 3734-3759	73.42	1865
146, 149	3708, 3785	74.42	1890
150-151, 153-154	3810-3853, 3886-3912	76.42	1941
152, 155	3861, 3937	77.42	1966
156-157, 159-160	3962-3988, 4039-4064	79.42	2017
158, 161	4013, 4089	80.42	2043
162-163, 165-166	4115-4140, 4191-4216	82.42	2093
164, 167	4166, 4242	83.42	2119
168-169, 171-172	4267-4293, 4343-4369	85.42	2170
170, 173	4318, 4394	86.42	2195
174-175, 177-178	4420-4445, 4496-4521	88.42	2246
176, 179	4470, 4547	89.42	2271

SERIES 1500-1

BELTS COVERED IN SECTION

- Flush Grid
- Flush Grid with Contained Edge

NOTE: Before use in food-safe applications, follow good manufacturing practice and thoroughly clean and sanitize belts according to your standard sanitary operating procedures.

BELT RUN DIRECTION

S1500 belts have a preferred run direction. When run in this direction, the belt has a longer belt life and the rods do not wear prematurely. A run direction arrow is molded into the top surface of the flush edge module. If the run direction arrow wears off, the preferred drive surface is the solid round surface on the wide barrel link.

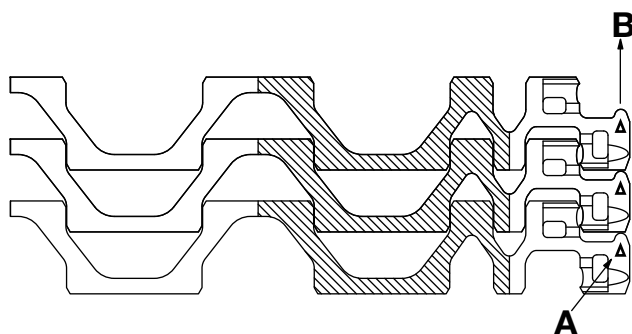

A Direction arrow
B Run direction
Figure 167: Running direction

UNHEADED ROD

INSERT THE ROD

1. Cut rods 0.4 in (10 mm) shorter than the overall belt width.
2. Join belt ends together so the hinges are aligned.

3. Use the insertion guide notch as a guide to insert the rod through the hinges until it snaps in place.

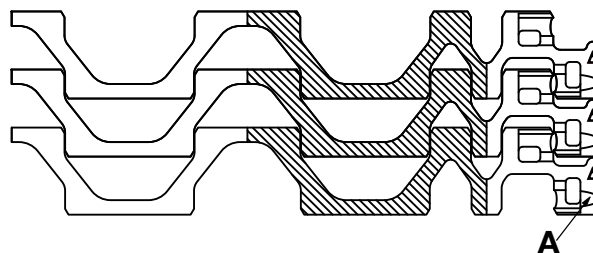

A Insertion guide notch
Figure 168: Use insertion guide notch as guide

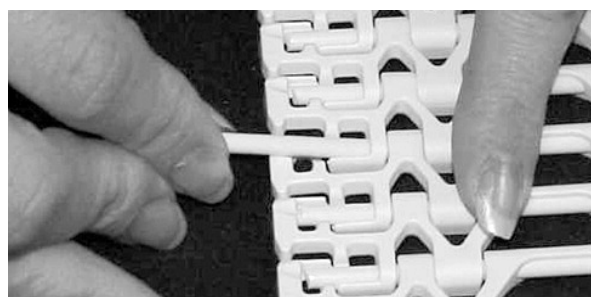

Figure 169: Insert rod through hinges

REMOVE THE ROD

1. While slightly depressing one belt edge, insert a screwdriver on the opposite edge between the module and rod.
2. Use the screwdriver to push the rod out of the other belt edge (toward the depressed edge module).

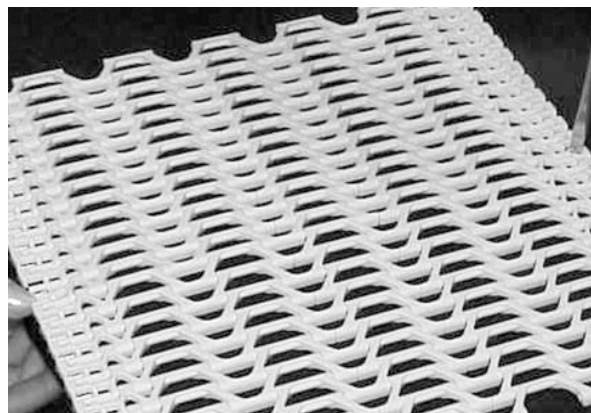

Figure 170: Push rod from belt

- Once past the belt edge, pull the rod out to open the belt.

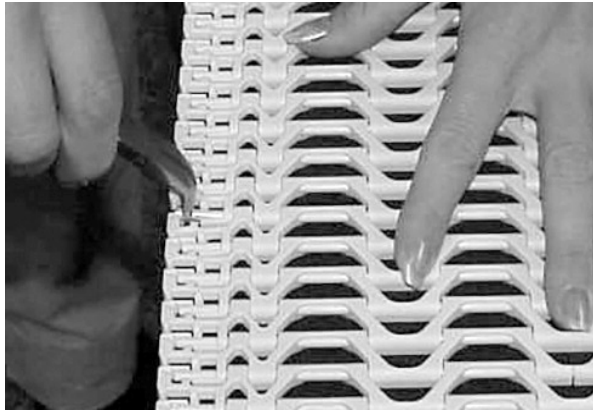
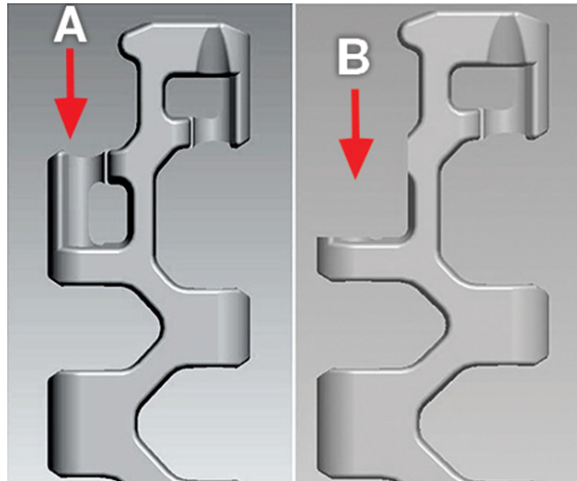

Figure 171: Pull rod from belt

SPLICING CONTAINED EDGE BELT TO ORIGINAL BELT

- With minor changes to the flush edge of the original belt, the new belt design can be spliced into original belts.
- Cut material from the retention feature of the original flush edge design.



A Before cut

B After cut

Figure 172: Cut retention feature

LOCKED SPROCKET LOCATION

Link Count	Nominal Belt Width		Center From Edge		Center Sprocket Location
	in	mm	in	mm	
4	8	203	4	102	Center
4.25	8.5	216	4.25	108	Center
4.5	9	229	4.5	114	0.25 in (6 mm) off center to the left
4.75	9.5	241	4.75	121	Center
5	10	254	5	127	1 in (25 mm) off center
5.25	10.5	267	5.25	133	1 in (25 mm) off center
5.5	11	279	5.5	140	1.25 in (32 mm) off center to the left
5.75	11.5	292	5.75	146	1 in (25 mm) off center
6	12	305	6	152	Center
6.25	12.5	318	6.25	159	Center
6.5	13	330	6.5	165	0.25 in (6 mm) off center to the left
6.75	13.5	343	6.75	171	Center
7	14	356	7	178	1 in (25 mm) off center
7.25	14.5	368	7.25	184	1 in (25 mm) off center
7.5	15	381	7.5	191	1.25 in (32 mm) off center to the left
7.75	15.5	394	7.75	197	1 in (25 mm) off center
8	16	406	8	203	Center
8.25	16.5	419	8.25	210	Center
8.5	17	432	8.5	216	0.25 in (6 mm) off center to the left
8.75	17.5	445	8.75	222	Center
9	18	457	9	229	1 in (25 mm) off center
9.25	18.5	470	9.25	235	1 in (25 mm) off center
9.5	19	483	9.5	241	1.25 in (32 mm) off center to the left
9.75	19.5	495	9.75	248	1 in (25 mm) off center
10	20	508	10	254	Center
10.25	20.5	521	10.25	260	Center

Link Count	Nominal Belt Width		Center From Edge		Center Sprocket Location
	in	mm	in	mm	
10.5	21	533	10.5	267	0.25 in (6 mm) off center to the left
10.75	21.5	546	10.75	273	Center
11	22	559	11	279	1 in (25 mm) off center
11.25	22.5	572	11.25	286	1 in (25 mm) off center
11.5	23	584	11.5	292	1.25 in (32 mm) off center to the left
11.75	23.5	597	11.75	298	1 in (25 mm) off center
12	24	610	12	305	Center
12.25	24.5	622	12.25	311	Center
12.5	25	635	12.5	318	0.25 in (6 mm) off center to the left
12.75	25.5	648	12.75	324	Center
13	26	660	13	330	1 in (25 mm) off center
13.25	26.5	673	13.25	337	1 in (25 mm) off center
13.5	27	686	13.5	343	1.25 in (32 mm) off center to the left
13.75	27.5	699	13.75	349	1 in (25 mm) off center
14	28	711	14	356	Center
14.25	28.5	724	14.25	362	Center
14.5	29	737	14.5	368	0.25 in (6 mm) off center to the left
14.75	29.5	749	14.75	375	Center
15	30	762	15	381	1 in (25 mm) off center
15.25	30.5	775	15.25	387	1 in (25 mm) off center
15.5	31	787	15.5	394	1.25 in (32 mm) off center to the left
15.75	31.5	800	15.75	400	1 in (25 mm) off center
16	32	813	16	406	Center
16.25	32.5	826	16.25	413	Center
16.5	33	838	16.5	419	0.25 in (6 mm) off center to the left
16.75	33.5	851	16.75	425	Center
17	34	864	17	432	1 in (25 mm) off center

Link Count	Nominal Belt Width		Center From Edge		Center Sprocket Location
	in	mm	in	mm	
17.25	34.5	876	17.25	438	1 in (25 mm) off center
17.5	35	889	17.5	445	1.25 in (32 mm) off center to the left
17.75	35.5	902	17.75	451	1 in (25 mm) off center
18	36	914	18	457	Center
18.25	36.5	927	18.25	464	Center
18.5	37	940	18.5	470	0.25 in (6 mm) off center to the left
18.75	37.5	953	18.75	476	Center
19	38	965	19	483	1 in (25 mm) off center
19.25	38.5	978	19.25	489	1 in (25 mm) off center
19.5	39	991	19.5	495	1.25 in (32 mm) off center to the left
19.75	39.5	1003	19.75	502	1 in (25 mm) off center
20	40	1016	20	508	Center
20.25	40.5	1029	20.25	514	Center
20.5	41	1041	20.5	521	0.25 in (6 mm) off center to the left
20.75	41.5	1054	20.75	527	Center
21	42	1067	21	533	1 in (25 mm) off center
21.25	42.5	1080	21.25	540	1 in (25 mm) off center
21.5	43	1092	21.5	546	1.25 in (32 mm) off center to the left
21.75	43.5	1105	21.75	552	1 in (25 mm) off center
22	44	1118	22	559	Center
22.25	44.5	1130	22.25	565	Center
22.5	45	1143	22.5	572	0.25 in (6 mm) off center to the left
22.75	45.5	1156	22.75	578	Center
23	46	1168	23	584	1 in (25 mm) off center
23.25	46.5	1181	23.25	591	1 in (25 mm) off center
23.5	47	1194	23.5	597	1.25 in (32 mm) off center to the left
23.75	47.5	1207	23.75	603	1 in (25 mm) off center

SERIES 1500-1

Link Count	Nominal Belt Width		Center From Edge		Center Sprocket Location
	in	mm	in	mm	
24	48	1219	24	610	Center
24.25	48.5	1232	24.25	616	Center
24.5	49	1245	24.5	622	0.25 in (6 mm) off center to the left
24.75	49.5	1257	24.75	629	Center
25	50	1270	25	635	1 in (25 mm) off center
25.25	50.5	1283	25.25	641	1 in (25 mm) off center
25.5	51	1295	25.5	648	1.25 in (32 mm) off center to the left
25.75	51.5	1308	25.75	654	1 in (25 mm) off center
26	52	1321	26	660	Center
26.25	52.5	1334	26.25	667	Center
26.5	53	1346	26.5	673	0.25 in (6 mm) off center to the left
26.75	53.5	1359	26.75	679	Center
27	54	1372	27	686	1 in (25 mm) off center
27.25	54.5	1384	27.25	692	1 in (25 mm) off center
27.5	55	1397	27.5	699	1.25 in (32 mm) off center to the left
27.75	55.5	1410	27.75	705	1 in (25 mm) off center
28	56	1422	28	711	Center
28.25	56.5	1435	28.25	718	Center
28.5	57	1448	28.5	724	0.25 in (6 mm) off center to the left
28.75	57.5	1461	28.75	730	Center
29	58	1473	29	737	1 in (25 mm) off center
29.25	58.5	1486	29.25	743	1 in (25 mm) off center
29.5	59	1499	29.5	749	1.25 in (32 mm) off center to the left
29.75	59.5	1511	29.75	756	1 in (25 mm) off center
30	60	1524	30	762	Center
30.25	60.5	1537	30.25	768	Center
30.5	61	1549	30.5	775	0.25 in (6 mm) off center to the left
30.75	61.5	1562	30.75	781	Center

Link Count	Nominal Belt Width		Center From Edge		Center Sprocket Location
	in	mm	in	mm	
31	62	1575	31	787	1 in (25 mm) off center
31.25	62.5	1588	31.25	794	1 in (25 mm) off center
31.5	63	1600	31.5	800	1.25 in (32 mm) off center to the left
31.75	63.5	1613	31.75	806	1 in (25 mm) off center
32	64	1626	32	813	Center
32.25	64.5	1638	32.25	819	Center
32.5	65	1651	32.5	826	0.25 in (6 mm) off center to the left
32.75	65.5	1664	32.75	832	Center
33	66	1676	33	838	1 in (25 mm) off center
33.25	66.5	1689	33.25	845	1 in (25 mm) off center
33.5	67	1702	33.5	851	1.25 in (32 mm) off center to the left
33.75	67.5	1715	33.75	857	1 in (25 mm) off center
34	68	1727	34	864	Center
34.25	68.5	1740	34.25	870	Center
34.5	69	1753	34.5	876	0.25 in (6 mm) off center to the left
34.75	69.5	1765	34.75	883	Center
35	70	1778	35	889	1 in (25 mm) off center
35.25	70.5	1791	35.25	895	1 in (25 mm) off center
35.5	71	1803	35.5	902	1.25 in (32 mm) off center to the left
35.75	71.5	1816	35.75	908	1 in (25 mm) off center
36	72	1829	36	914	Center
36.25	72.5	1842	36.25	921	Center
36.5	73	1854	36.5	927	0.25 in (6 mm) off center to the left
36.75	73.5	1867	36.75	933	Center
37	74	1880	37	940	1 in (25 mm) off center
37.25	74.5	1892	37.25	946	1 in (25 mm) off center
37.5	75	1905	37.5	953	1.25 in (32 mm) off center to the left

Link Count	Nominal Belt Width		Center From Edge		Center Sprocket Location
	in	mm	in	mm	
37.75	75.5	1918	37.75	959	1 in (25 mm) off center
38	76	1930	38	965	Center
38.25	76.5	1943	38.25	972	Center
38.5	77	1956	38.5	978	0.25 in (6 mm) off center to the left
38.75	77.5	1969	38.75	984	Center
39	78	1981	39	991	1 in (25 mm) off center
39.25	78.5	1994	39.25	997	1 in (25 mm) off center
39.5	79	2007	39.5	1003	1.25 in (32 mm) off center to the left
39.75	79.5	2019	39.75	1010	1 in (25 mm) off center
40	80	2032	40	1016	Center
40.25	80.5	2045	40.25	1022	Center
40.5	81	2057	40.5	1029	0.25 in (6 mm) off center to the left
40.75	81.5	2070	40.75	1035	Center
41	82	2083	41	1041	1 in (25 mm) off center
41.25	82.5	2096	41.25	1048	1 in (25 mm) off center
41.5	83	2108	41.5	1054	1.25 in (32 mm) off center to the left
41.75	83.5	2121	41.75	1060	1 in (25 mm) off center
42	84	2134	42	1067	Center
42.25	84.5	2146	42.25	1073	Center
42.5	85	2159	42.5	1080	0.25 in (6 mm) off center to the left
42.75	85.5	2172	42.75	1086	Center
43	86	2184	43	1092	1 in (25 mm) off center
43.25	86.5	2197	43.25	1099	1 in (25 mm) off center
43.5	87	2210	43.5	1105	1.25 in (32 mm) off center to the left
43.75	87.5	2223	43.75	1111	1 in (25 mm) off center
44	88	2235	44	1118	Center
44.25	88.5	2248	44.25	1124	Center
44.5	89	2261	44.5	1130	0.25 in (6 mm) off center to the left

Link Count	Nominal Belt Width		Center From Edge		Center Sprocket Location
	in	mm	in	mm	
44.75	89.5	2273	44.75	1137	Center
45	90	2286	45	1143	1 in (25 mm) off center
45.25	90.5	2299	45.25	1149	1 in (25 mm) off center
45.5	91	2311	45.5	1156	1.25 in (32 mm) off center to the left
45.75	91.5	2324	45.75	1162	1 in (25 mm) off center
46	92	2337	46	1168	Center
46.25	92.5	2350	46.25	1175	Center
46.5	93	2362	46.5	1181	0.25 in (6 mm) off center to the left
46.75	93.5	2375	46.75	1187	Center
47	94	2388	47	1194	1 in (25 mm) off center
47.25	94.5	2400	47.25	1200	1 in (25 mm) off center
47.5	95	2413	47.5	1207	1.25 in (32 mm) off center to the left
47.75	95.5	2426	47.75	1213	1 in (25 mm) off center
48	96	2438	48	1219	Center
48.25	96.5	2451	48.25	1226	Center
48.5	97	2464	48.5	1232	0.25 in (6 mm) off center to the left
48.75	97.5	2477	48.75	1238	Center
49	98	2489	49	1245	1 in (25 mm) off center
49.25	98.5	2502	49.25	1251	1 in (25 mm) off center
49.5	99	2515	49.5	1257	1.25 in (32 mm) off center to the left
49.75	99.5	2527	49.75	1264	1 in (25 mm) off center
50	100	2540	50	1270	Center
50.25	100.5	2553	50.25	1276	Center
50.5	101	2565	50.5	1283	0.25 in (6 mm) off center to the left
50.75	101.5	2578	50.75	1289	Center
51	102	2591	51	1295	1 in (25 mm) off center
51.25	102.5	2604	51.25	1302	1 in (25 mm) off center

SERIES 1500-1

Link Count	Nominal Belt Width		Center From Edge		Center Sprocket Location
	in	mm	in	mm	
51.5	103	2616	51.5	1308	1.25 in (32 mm) off center to the left
51.75	103.5	2629	51.75	1314	1 in (25 mm) off center
52	104	2642	52	1321	Center
52.25	104.5	2654	52.25	1327	Center
52.5	105	2667	52.5	1334	0.25 in (6 mm) off center to the left
52.75	105.5	2680	52.75	1340	Center
53	106	2692	53	1346	1 in (25 mm) off center
53.25	106.5	2705	53.25	1353	1 in (25 mm) off center
53.5	107	2718	53.5	1359	1.25 in (32 mm) off center to the left
53.75	107.5	2731	53.75	1365	1 in (25 mm) off center
54	108	2743	54	1372	Center
54.25	108.5	2756	54.25	1378	Center
54.5	109	2769	54.5	1384	0.25 in (6 mm) off center to the left
54.75	109.5	2781	54.75	1391	Center
55	110	2794	55	1397	1 in (25 mm) off center
55.25	110.5	2807	55.25	1403	1 in (25 mm) off center
55.5	111	2819	55.5	1410	1.25 in (32 mm) off center to the left
55.75	111.5	2832	55.75	1416	1 in (25 mm) off center
56	112	2845	56	1422	Center
56.25	112.5	2858	56.25	1429	Center
56.5	113	2870	56.5	1435	0.25 in (6 mm) off center to the left
56.75	113.5	2883	56.75	1441	Center
57	114	2896	57	1448	1 in (25 mm) off center
57.25	114.5	2908	57.25	1454	1 in (25 mm) off center
57.5	115	2921	57.5	1461	1.25 in (32 mm) off center to the left
57.75	115.5	2934	57.75	1467	1 in (25 mm) off center
58	116	2946	58	1473	Center
58.25	116.5	2959	58.25	1480	Center

Link Count	Nominal Belt Width		Center From Edge		Center Sprocket Location
	in	mm	in	mm	
58.5	117	2972	58.5	1486	0.25 in (6 mm) off center to the left
58.75	117.5	2985	58.75	1492	Center
59	118	2997	59	1499	1 in (25 mm) off center
59.25	118.5	3010	59.25	1505	1 in (25 mm) off center
59.5	119	3023	59.5	1511	1.25 in (32 mm) off center to the left
59.75	119.5	3035	59.75	1518	1 in (25 mm) off center
60	120	3048	60	1524	Center
60.25	120.5	3061	60.25	1530	Center
60.5	121	3073	60.5	1537	0.25 in (6 mm) off center to the left
60.75	121.5	3086	60.75	1543	Center
61	122	3099	61	1549	1 in (25 mm) off center
61.25	122.5	3112	61.25	1556	1 in (25 mm) off center
61.5	123	3124	61.5	1562	1.25 in (32 mm) off center to the left
61.75	123.5	3137	61.75	1568	1 in (25 mm) off center
62	124	3150	62	1575	Center
62.25	124.5	3162	62.25	1581	Center
62.5	125	3175	62.5	1588	0.25 in (6 mm) off center to the left
62.75	125.5	3188	62.75	1594	Center
63	126	3200	63	1600	1 in (25 mm) off center
63.25	126.5	3213	63.25	1607	1 in (25 mm) off center
63.5	127	3226	63.5	1613	1.25 in (32 mm) off center to the left
63.75	127.5	3239	63.75	1619	1 in (25 mm) off center
64	128	3251	64	1626	Center
64.25	128.5	3264	64.25	1632	Center
64.5	129	3277	64.5	1638	0.25 in (6 mm) off center to the left
64.75	129.5	3289	64.75	1645	Center
65	130	3302	65	1651	1 in (25 mm) off center

Link Count	Nominal Belt Width		Center From Edge		Center Sprocket Location
	in	mm	in	mm	
65.25	130.5	3315	65.25	1657	1 in (25 mm) off center
65.5	131	3327	65.5	1664	1.25 in (32 mm) off center to the left
65.75	131.5	3340	65.75	1670	1 in (25 mm) off center
66	132	3353	66	1676	Center
66.25	132.5	3366	66.25	1683	Center
66.5	133	3378	66.5	1689	0.25 in (6 mm) off center to the left
66.75	133.5	3391	66.75	1695	Center
67	134	3404	67	1702	1 in (25 mm) off center
67.25	134.5	3416	67.25	1708	1 in (25 mm) off center
67.5	135	3429	67.5	1715	1.25 in (32 mm) off center to the left
67.75	135.5	3442	67.75	1721	1 in (25 mm) off center
68	136	3454	68	1727	Center
68.25	136.5	3467	68.25	1734	Center
68.5	137	3480	68.5	1740	0.25 in (6 mm) off center to the left
68.75	137.5	3493	68.75	1746	Center
69	138	3505	69	1753	1 in (25 mm) off center
69.25	138.5	3518	69.25	1759	1 in (25 mm) off center
69.5	139	3531	69.5	1765	1.25 in (32 mm) off center to the left
69.75	139.5	3543	69.75	1772	1 in (25 mm) off center
70	140	3556	70	1778	Center
70.25	140.5	3569	70.25	1784	Center
70.5	141	3581	70.5	1791	0.25 in (6 mm) off center to the left
70.75	141.5	3594	70.75	1797	Center
71	142	3607	71	1803	1 in (25 mm) off center

SERIES 1600-1

BELTS COVERED IN SECTION

- Mesh Top™
- Mesh Nub Top™
- Mini Rib
- Mold to Width Open Hinge Flat Top
- Nub Top™
- Open Hinge Flat Top
- Raised Open Grid

NOTE: Before use in food-safe applications, follow good manufacturing practice and thoroughly clean and sanitize belts according to your standard sanitary operating procedures.

UNHEADED ROD

INSERT THE ROD

1. Cut rods 0.5 in (12.7 mm) shorter than the overall belt width.
2. Join belt ends together so the hinges are aligned.
3. Insert the rod through the hinges as far as possible.

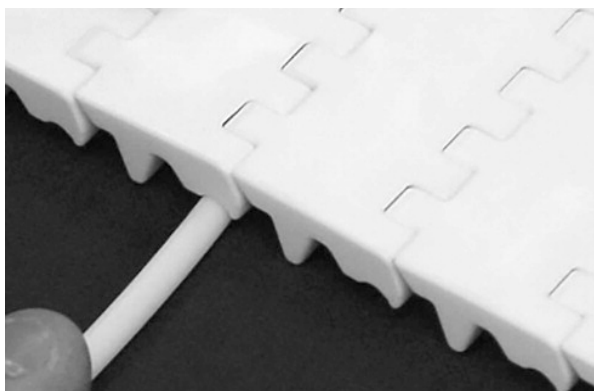

Figure 173: Insert rod through hinges

4. Use a screwdriver to push the rod past the retention feature.



Figure 174: Push rod past retention feature

5. Ensure the rod is fully inserted.

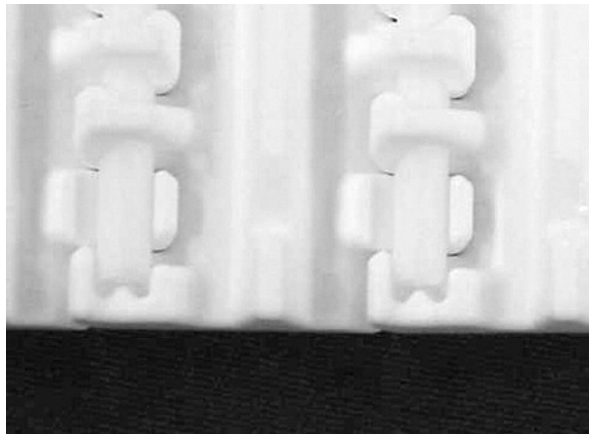

Figure 175: Ensure rod is past retention feature

REMOVE THE ROD

1. On the bottom side of the belt, insert a screwdriver between the rod and the belt.
2. Twist the screwdriver to lift the rod over the retention feature. Repeat this process until the rod tip is past the belt edge.

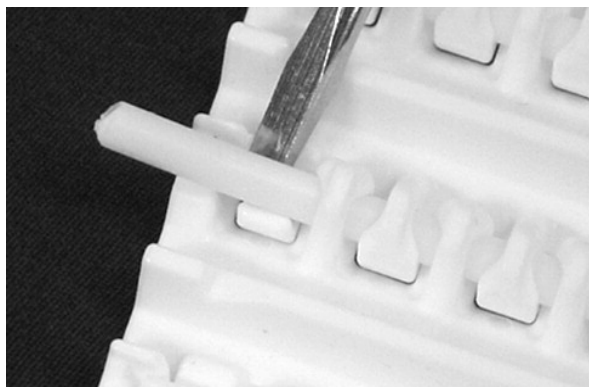

Figure 176: Lift rod over retention feature

SERIES 1600-1

3. Once past the belt edge, pull the rod out to open the belt.

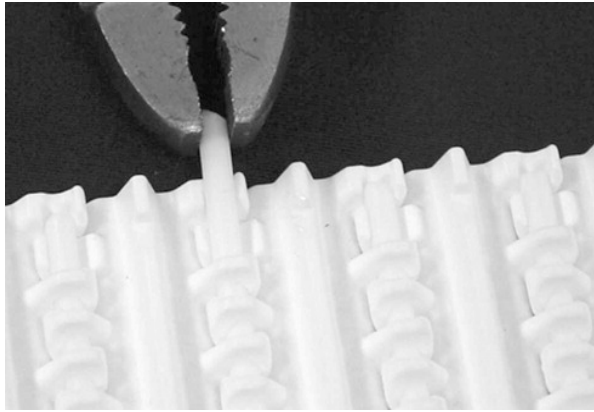

Figure 177: Pull rod from belt

SERIES 1650-1

BELTS COVERED IN SECTION

- SeamFree™ Minimum Hinge Flat Top

NOTE: Before use in food-safe applications, follow good manufacturing practice and thoroughly clean and sanitize belts according to your standard sanitary operating procedures.

PREFORMED HEADED ROD

INSERT THE ROD

1. Cut rods 0.60 in (15.2 mm) shorter than the overall belt width.
2. Join belt ends together so the hinges are aligned.
3. Insert the rod through the hinges until the rod head touches the belt edge.

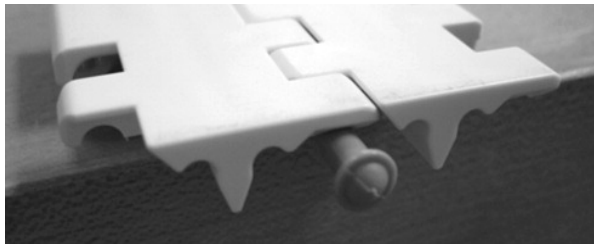

Figure 178: Insert rod through hinges

4. Use your thumb to push the rod head forward until it snaps into the retention feature.

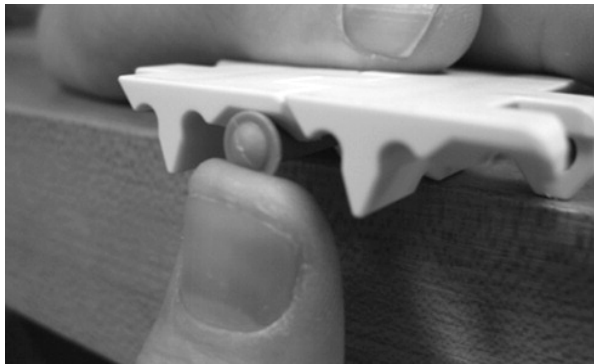

Figure 179: Use thumb to push rod

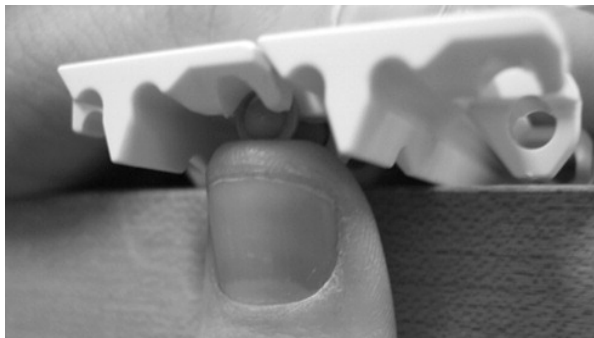

Figure 180: Push rod past retention feature

5. Ensure the rod is fully inserted.



Figure 181: Ensure rod is fully inserted

REMOVE THE ROD

1. From the bottom of the belt, cut off the rod heads.

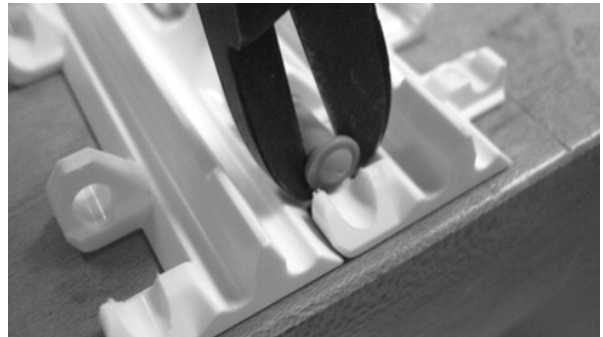

Figure 182: Cut rod head

2. Grip and pull the rod out to open the belt.

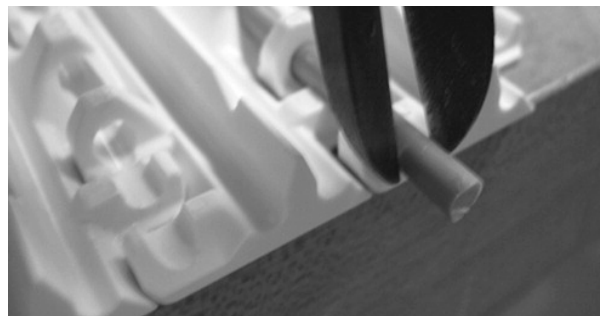

Figure 183: Pull rod from belt

SERIES 1700-1

BELTS COVERED IN SECTION

- Flush Grid
- Flush Grid Nub Top

NOTE: Before use in food-safe applications, follow good manufacturing practice and thoroughly clean and sanitize belts according to your standard sanitary operating procedures.

UNHEADED ROD & SLIDELOX RETAINER

INSERT THE RODS

1. On one belt edge, ensure the Slidelox is closed. If not, use a screwdriver to slide the latch to close the Slidelox.
2. On the opposite belt edge, ensure the Slidelox is open. If not, use a screwdriver to slide the latch to open the Slidelox.

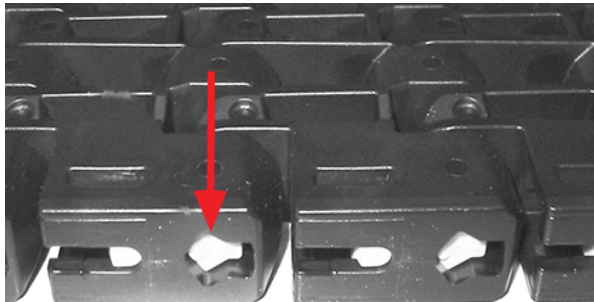

Figure 184: Open Slidelox

3. Join belt ends together so the hinges are aligned.
4. Ensure the rods are rotated so they stand on the short edge flat against one another.
5. Insert the rods through the open Slidelox.

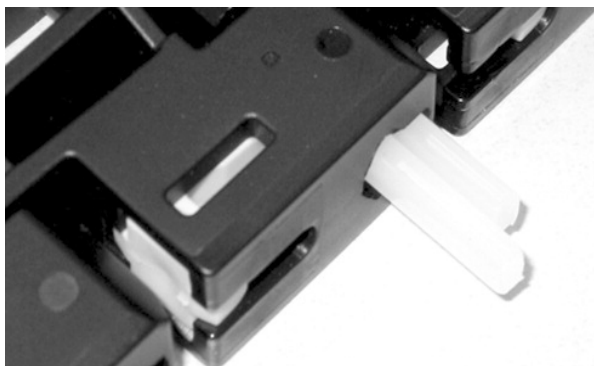

Figure 185: Insert rod through hinges

6. Once the rods are inserted, slide the latch to close the Slidelox. The Slidelox snaps when closed.

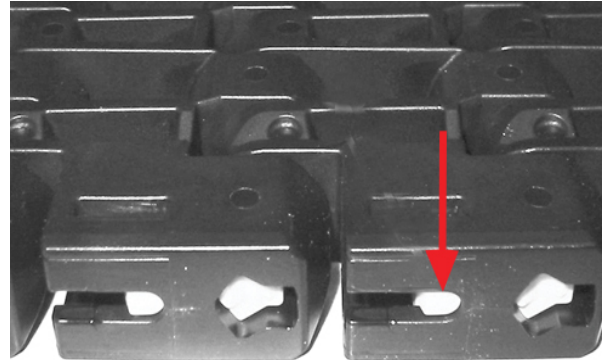

Figure 186: Close Slidelox

NOTE: Ensure ALL Slidelox are closed after installation.

REMOVE THE RODS

NOTE: DO NOT remove Slidelox from edge modules. Removal can destroy the Slidelox and module.

1. Use a screwdriver to open the Slidelox on both belt edges.

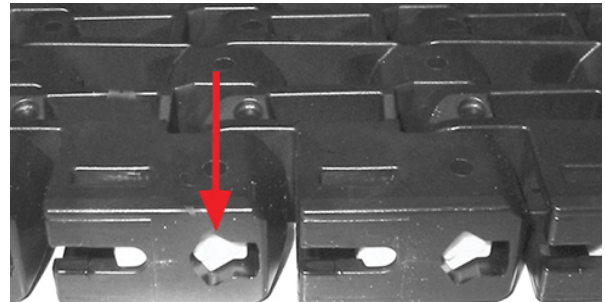

Figure 187: Open Slidelox

2. Use a screwdriver to push the rods out of the belt.

SERIES 1700-1

3. Once the rods are removed, slide the latch to close the Slidelox. The Slidelox snaps when closed.

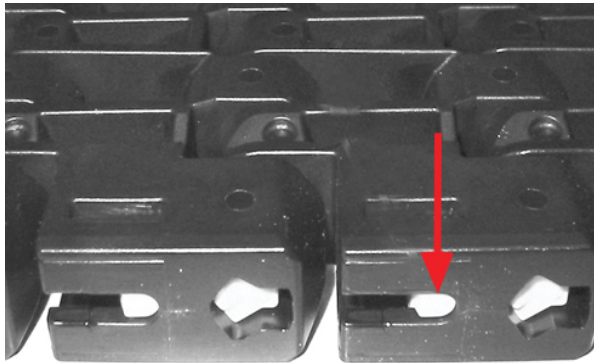

Figure 188: Close Slidelox

NOTE: Ensure ALL Slidelox are closed after installation.

SERIES 1700-2

BELTS COVERED IN SECTION

- Transverse Roller Top™ (TRT™)

NOTE: Before use in food-safe applications, follow good manufacturing practice and thoroughly clean and sanitize belts according to your standard sanitary operating procedures.

OVERVIEW

The S1700 TRT belt row pattern is not typical. Every other row is a repeat pattern of the rollers on the top surface of the belt. One row has the roller with no indent and the other row has a roller indent of 1 in (25.4 mm). Because of this, S1700 TRT must be assembled in two-row increments.



Figure 189: Assemble in two-row increments

The rod type for S1700 TRT is 0.312 in (7.9 mm) diameter. This is different than S1700 Flush Grid or S1700 Flush Grid Nub Top.

UNHEADED ROD

INSERT THE ROD

NOTE: A 0.25 in (6.4 mm) diameter steel pin is required for rod insertion.

1. Join belt ends together so the hinges are aligned.
2. Insert the rod through the hinges as far as possible.

3. Use a 0.25 in (6.4 mm) steel pin to push in the remaining rod past the retention feature.

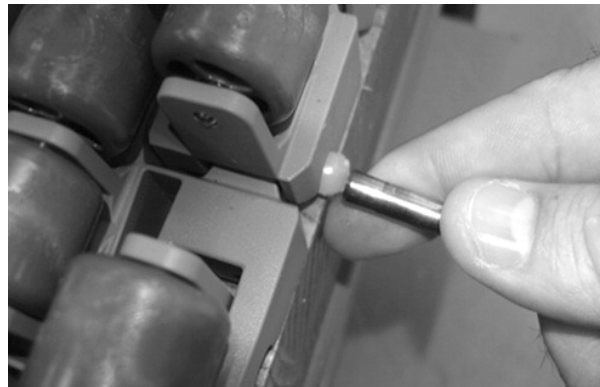
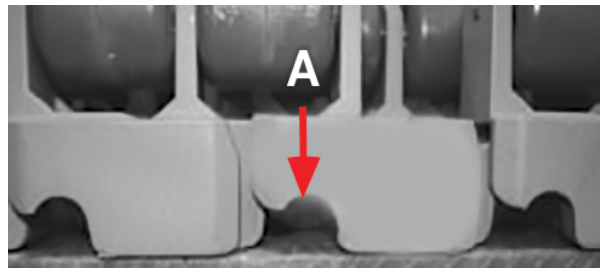

Figure 190: Push rod past retention feature

4. Ensure the rod is fully inserted.



A Retention feature

Figure 191: Ensure rod is past retention feature

REMOVE THE ROD

NOTE: Tools needed include a hammer, small screwdriver and 0.25 in (6.4 mm) diameter steel pin.

1. Insert a small screwdriver under the roller above the hinge where the rod will be removed.



Figure 192: Insert screwdriver under roller

2. With the screwdriver still in place, place the steel pin in the hinge on the opposite belt edge and use the hammer to tap the rod out from the belt. Angle the steel pin slightly to contact the rod and not the link.



Figure 193: Insert steel pin in hinge



Figure 194: Push rod from belt

3. Once past the belt edge, pull the rod out to open the belt.



Figure 195: Pull rod from belt

CHECK CONVEYOR

1. Inspect the returnway rollers to ensure the diameter is equal to or greater than 6 in (152.4 mm). The S1700 TRT has a minimum back bend of 6 in (152.4 mm) diameter.

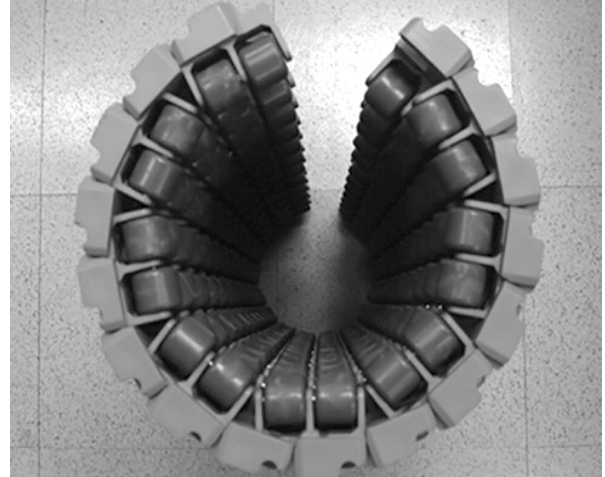
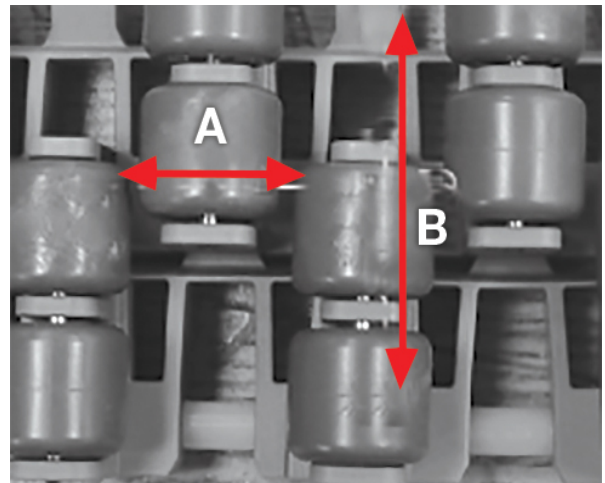

Figure 196: Inspect rollers

2. Inspect conveyor rollers for contact with conveyor components other than return rollers.

NOTE: S1700 TRT is not recommended for product accumulation conditions because the roller is designed to roll in the transverse direction. If the rollers contact conveyor components, the roller can wear to a non-circular shape.



- A** Roller movement
- B** Belt movement

Figure 197: Roller movement and belt direction of travel

SERIES 1750-1

BELTS COVERED IN SECTION

- Flush Grid

NOTE: Before use in food-safe applications, follow good manufacturing practice and thoroughly clean and sanitize belts according to your standard sanitary operating procedures.

UNHEADED ROD & SLIDELOX RETAINER

INSERT THE RODS

1. On one belt edge, ensure the Slidelox is closed. If not, use a screwdriver to slide the latch to close the Slidelox.
2. On the opposite belt edge, ensure the Slidelox is open. If not, use a screwdriver to slide the latch to open the Slidelox.

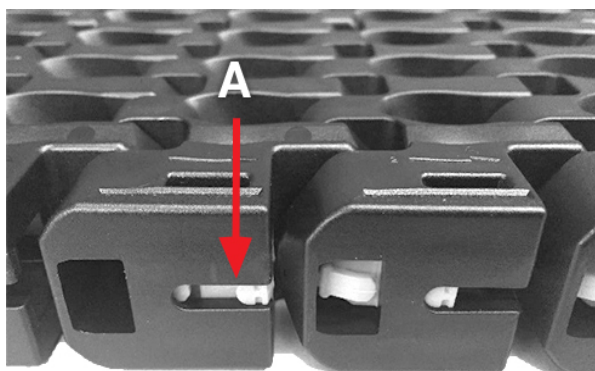

A Slidelox

Figure 198: Open Slidelox

3. Join belt ends together so the hinges are aligned.
4. Ensure the rod is rotated so the round edge faces the preferred run direction (indicated by arrow on belt edge).

5. Insert the rod through the open Slidelox.

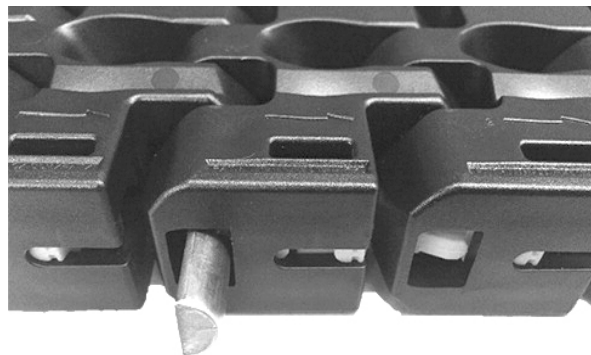
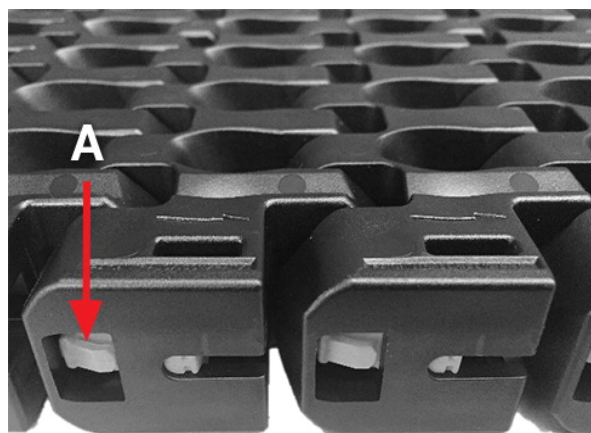

Figure 199: Insert rod

6. Once the rods are inserted, slide the latch to close the Slidelox. The Slidelox snaps when closed.



A Slidelox

Figure 200: Close Slidelox

NOTE: Ensure ALL Slidelox are closed after installation.

REMOVE THE RODS

NOTE: DO NOT remove Slidelox from edge modules. Removal can destroy the Slidelox and module.

1. Use a screwdriver to open the Slidelox on both belt edges.

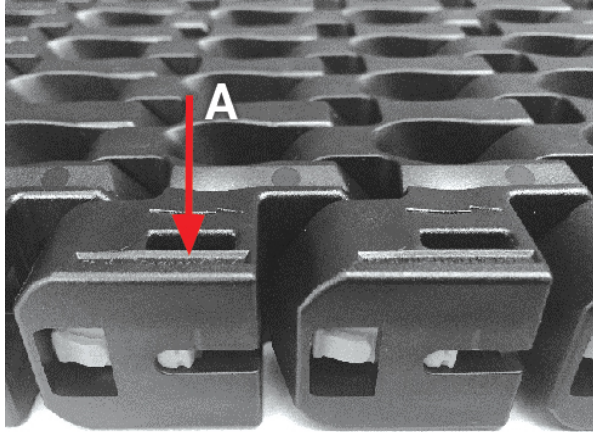

A Slidelox

Figure 201: Open Slidelox

2. Use a screwdriver to push the rods out of the belt.
3. Once the rods are removed, slide the latch to close the Slidelox. The Slidelox snaps when closed.

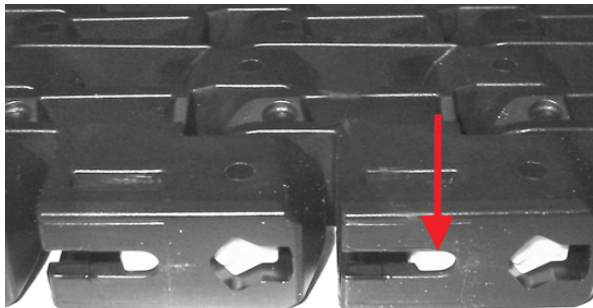

Figure 202: Close Slidelox

NOTE: Ensure all Slidelox are closed after installation.

SERIES 1800-1

BELTS COVERED IN SECTION

- Flat Top
- Mesh Top

NOTE: Before use in food-safe applications, follow good manufacturing practice and thoroughly clean and sanitize belts according to your standard sanitary operating procedures.

UNHEADED ROD

INSERT THE ROD

1. Cut rods 0.6 in (15 mm) shorter than the overall belt width.
2. Join belt ends together so the hinges are aligned.
3. Insert the rod through the hinges as far as possible.

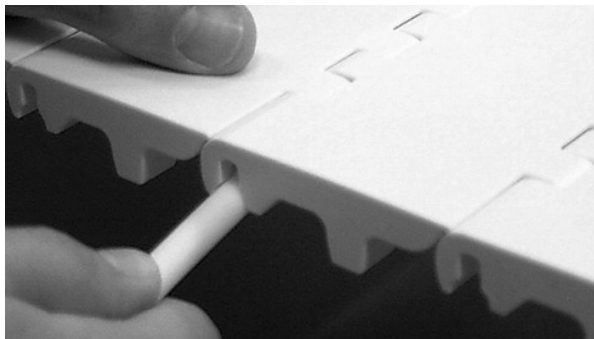

Figure 203: Insert rod through hinges

4. Use a screwdriver to push the rod past the retention feature.



Figure 204: Push rod past retention figure

5. Ensure the rod is fully inserted.

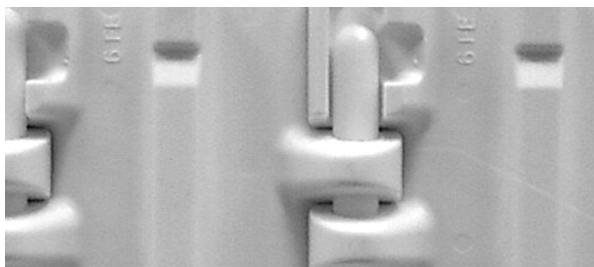

Figure 205: Ensure rod is past retention feature

REMOVE THE ROD

1. On the bottom side of the belt, insert a screwdriver between the rod and the belt.
2. Twist the screwdriver to lift the rod over the retention feature. Repeat this process until the rod tip is past the belt edge.



Figure 206: Lift rod over retention feature

3. Once past the belt edge, pull the rod out to open the belt.

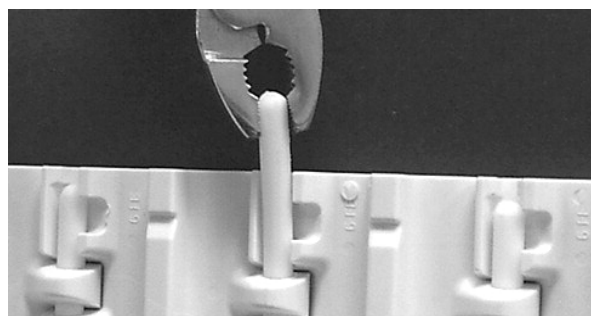

Figure 207: Pull rod from belt

SERIES 1800-2

BELTS COVERED IN SECTION

- Mesh Top with Slidelox

NOTE: Before use in food-safe applications, follow good manufacturing practice and thoroughly clean and sanitize belts according to your standard sanitary operating procedures.

UNHEADED ROD AND SLIDELOX RETAINER

INSERT THE ROD

1. On one belt edge, ensure the Slidelox is closed. If not, use a screwdriver to slide the latch to close the Slidelox.

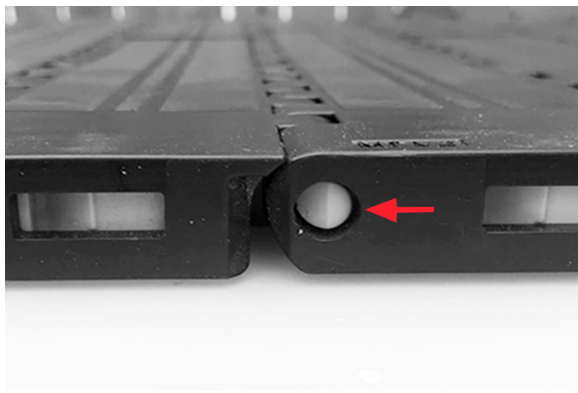

Figure 208: Slidelox in closed position



Figure 209: Use screwdriver to close Slidelox

2. On the opposite belt edge, ensure the Slidelox is open. If not, use a screwdriver to slide the latch to open the Slidelox.
3. Join belt ends together so the hinges are aligned.

4. Insert the rod through the open Slidelox.



Figure 210: Insert rod

5. Ensure the rod is inserted about 0.5 in (12.7 mm) past the belt edge.
6. Once the rod is inserted, close the Slidelox. The Slidelox snaps when closed.



Figure 211: Close the Slidelox

REMOVE THE ROD

NOTE: DO NOT remove Slidelox from edge modules. Removal can destroy the Slidelox and module.

SERIES 1800-2

1. Use a screwdriver to open the Slidelox on both belt edges.

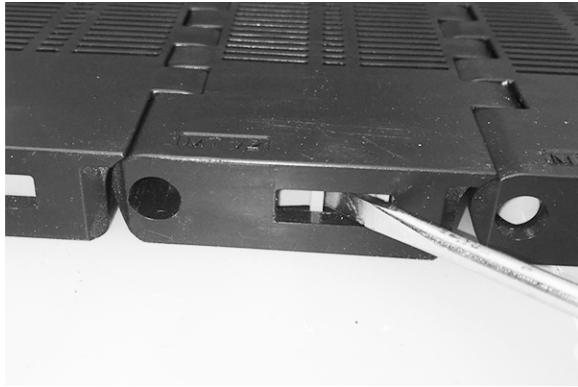

Figure 212: Open Slidelox

2. Use a screwdriver to push the rod out of the belt.

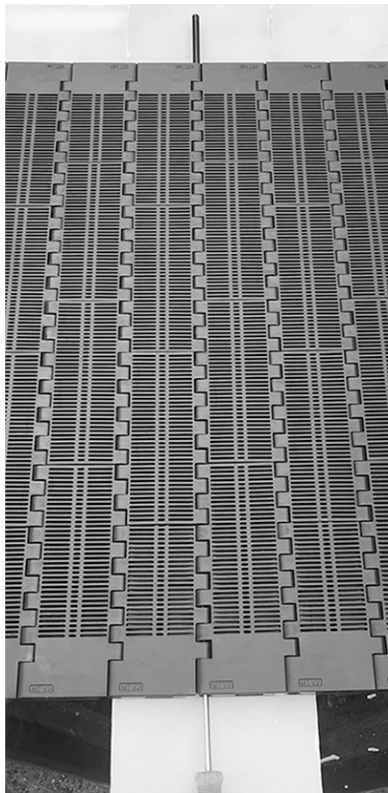

Figure 213: Push rod from belt

3. Once the rod is removed, slide the latch to close the Slidelox. The Slidelox snaps when closed.



Figure 214: Close the Slidelox

SERIES 1900-1

BELTS COVERED IN SECTION

- Raised Rib

NOTE: Before use in food-safe applications, follow good manufacturing practice and thoroughly clean and sanitize belts according to your standard sanitary operating procedures.

UNHEADED ROD & SHUTTLEPLUG RETAINER

INSERT THE ROD

1. Join belt ends together so the hinges are aligned.
2. On the belt edge containing the Shuttleplug, insert the rod into the hinge. The Shuttleplug slides open when the rod is inserted.

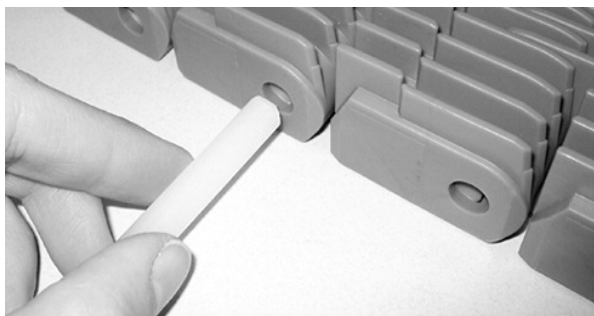

Figure 215: Insert rod through hinges

3. Use a screwdriver to push the rod past the Shuttleplug and fully into the belt.

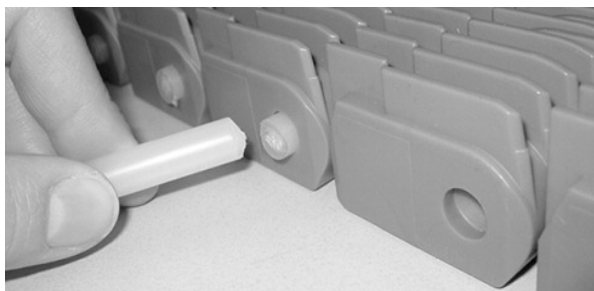

Figure 216: Push rod past Shuttleplug

4. Remove the screwdriver. The Shuttleplug closes when nothing is blocking it.

NOTE: Ensure ALL Shuttleplugs are closed after installation.

REMOVE THE ROD

1. On the belt edge containing the Shuttleplugs, insert a spare rod into the hinge just far enough to hold the Shuttleplug in the fully open position. The Shuttleplug slides open when the rod is inserted.



Figure 217: Open Shuttleplug

2. Insert a 0.25 in punch into the hinge on the opposite belt edge to push the spare rod and the belt rod past the Shuttleplug and out of the belt.
3. Once past the belt edge, pull the rod out to open the belt.



Figure 218: Pull rod from belt

LOCKED SPROCKET LOCATION

- Lock the center sprocket in place to retain the belt laterally. See the following table.
- Use the belt width to determine the locked sprocket location.
- All references are from the belt edge with the Shuttleplugs.

Location of the Center of the Locked Sprocket			
Nominal Belt Width Range		Distance from Shuttleplug Edge	
in	mm	in	mm
15-20	381-508	7.58	193
21-26	533-660	10.58	269
27-32	686-813	13.58	345
33-38	838-965	16.58	421
39-44	991-1118	19.58	497
45-50	1143-1270	22.58	574
51-56	1295-1422	25.58	650
57-62	1448-1575	28.58	726
63-68	1600-1727	31.58	802
69-74	1753-1880	34.58	878
75-80	1905-2032	37.58	955
81-86	2057-2184	40.58	1031
87-92	2210-2337	43.58	1107
93-98	2362-2489	46.58	1183
99-104	2515-2642	49.58	1259
105-110	2667-2794	52.58	1336
111-116	2819-2946	55.58	1412
117-122	2972-3099	58.58	1488
123-128	3124-3251	61.58	1564
129-134	3277-3404	64.58	1640
135-140	3429-3556	67.58	1717
141-146	3581-3708	70.58	1793
147-152	3734-3861	73.58	1869
153-158	3886-4013	76.58	1945
159-164	4039-4166	79.58	2021
165-170	4191-4318	82.58	2098
171-176	4343-4470	85.58	2174
177-182	4496-4623	88.58	2250
183-188	4648-4775	91.58	2326
189-194	4801-4928	94.58	2402

Location of the Center of the Locked Sprocket			
Nominal Belt Width Range		Distance from Shuttleplug Edge	
in	mm	in	mm
195-200	4953-5080	97.58	2479
201-206	5105-5232	100.58	2555
207-212	5258-5385	103.58	2631
213-218	5410-5537	106.58	2707
219-224	5563-5690	109.58	2783
225-230	5715-5842	112.58	2860
231-236	5867-5994	115.58	2936
237-242	6020-6147	118.58	3012

SERIES 4400-1

BELTS COVERED IN SECTION

- Transverse Roller Top™ (TRT™)

NOTE: Before use in food-safe applications, follow good manufacturing practice and thoroughly clean and sanitize belts according to your standard sanitary operating procedures.

OVERVIEW

- Series 4400 belts must be installed in 4 in (101.6 mm) two-row increments to maintain the staggered roller pattern as designed.
- Use belt pullers when installing and removing Series 4400 belts longer than 8 ft (2.44 m).



A Belt pullers

Figure 219: Use belt pullers for long belts

REMOVE THE ROD

1. On one belt edge, use a screwdriver to push the retention feature open.



Figure 220: Open retention feature

2. On the opposite belt edge, use a screwdriver to push the rod out of the belt.



Figure 221: Push rod from belt

UNHEADED ROD

INSERT THE ROD

1. Cut rods 2.0 in (50.8 mm) shorter than the overall belt width.
2. Join belt ends together so the hinges are aligned.
3. Insert the rod through the hinges as far as possible.
4. Use a screwdriver to push the rod past the retention feature.

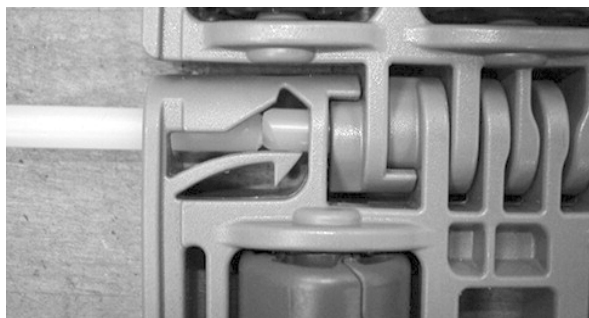

Figure 222: Push rod past retention feature

5. Ensure the rod is fully inserted.

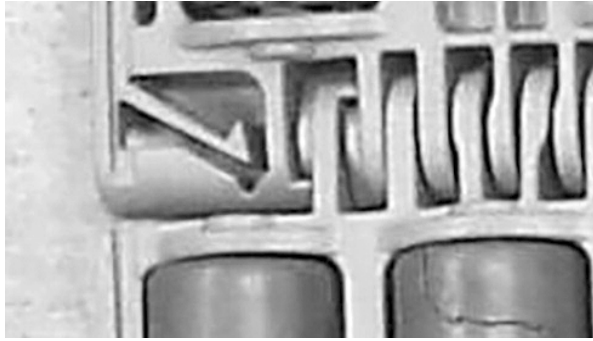

Figure 223: Ensure rod is past retention feature

SERIES 4500-1

BELTS COVERED IN SECTION

- Dual-Stacked Angled Roller™ Belt (DARB™)
- Flush Grid
- Left/Right Roller Top

NOTE: Before use in food-safe applications, follow good manufacturing practice and thoroughly clean and sanitize belts according to your standard sanitary operating procedures.

UNHEADED ROD

INSERT THE ROD

1. Join belt ends together so the hinges are aligned.
2. Insert the rod through the hinges as far as possible.

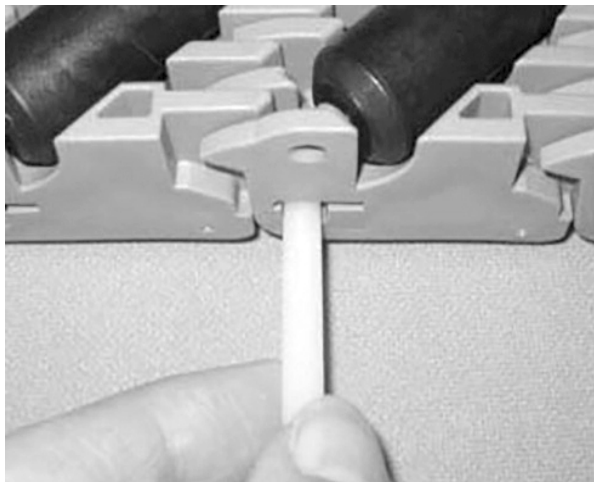

Figure 224: Insert rod through hinges

3. Use a screwdriver to push the rod past the retention feature.

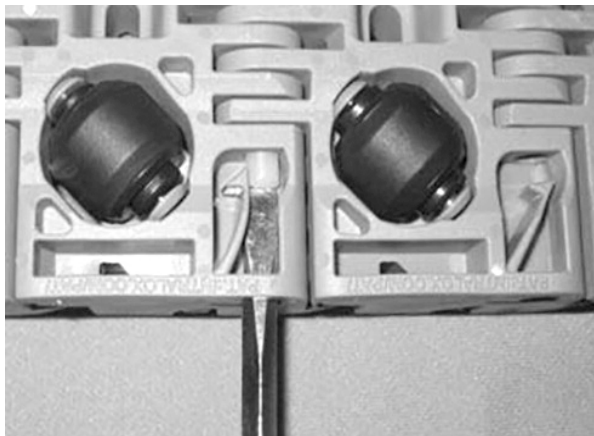

Figure 225: Push rod past retention feature

4. Ensure the rod is fully inserted.

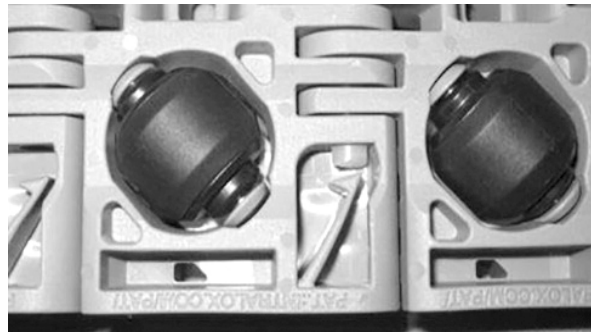

Figure 226: Ensure rod is past retention feature

REMOVE THE ROD

1. On one belt edge, use a screwdriver to push the retention feature open.
2. On the opposite belt edge, use a screwdriver to push the rod out of the belt.

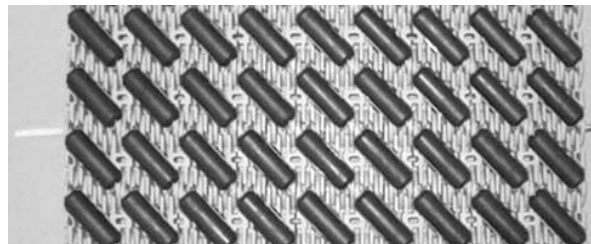
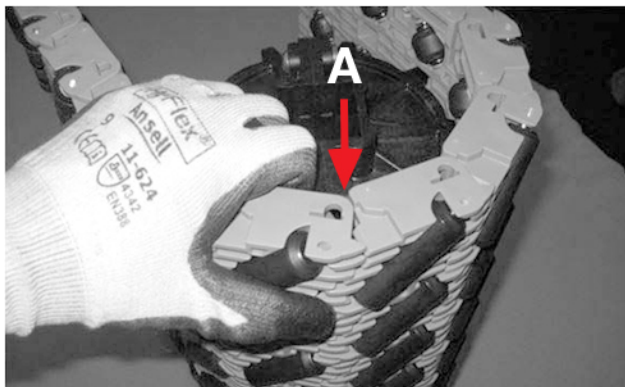

Figure 227: Push rod from belt

BELT HANDLING

The ribs of S4500 DARB are designed to maintain a closed deck as the belt wraps around the sprocket during normal operation. However, the ribs can open up and create a pinch point if it is hinged beyond what is possible with a sprocket. Because of this, wear gloves when handling this belt.



A Closed belt ribs

Figure 228: Normal hinge when wrapped around sprocket

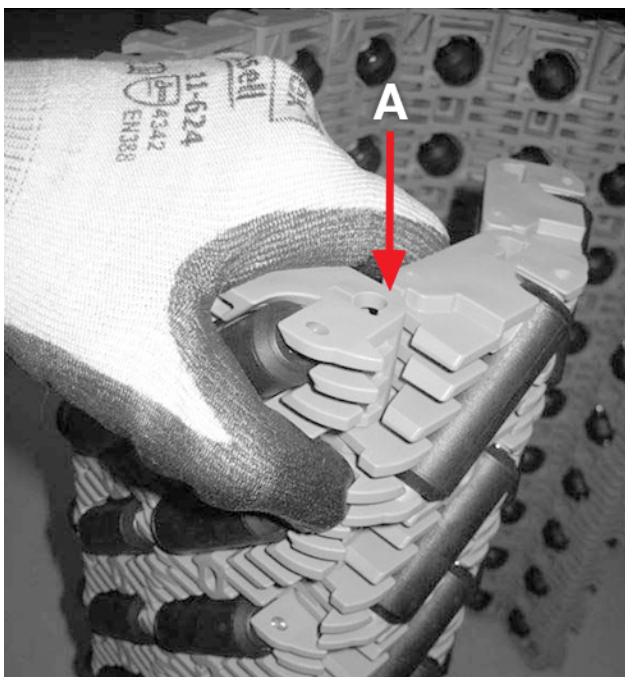

A Opened belt ribs

Figure 229: Exposed pinch point when hinged beyond normal

SERIES 4550-1

BELTS COVERED IN SECTION

- Dual-Stacked Angled Roller™ Belt (DARB™)

NOTE: Before use in food-safe applications, follow good manufacturing practice and thoroughly clean and sanitize belts according to your standard sanitary operating procedures.

UNHEADED ROD

INSERT THE ROD

1. Join belt ends together so the hinges are aligned.
2. Insert the rod through the hinges as far as possible.

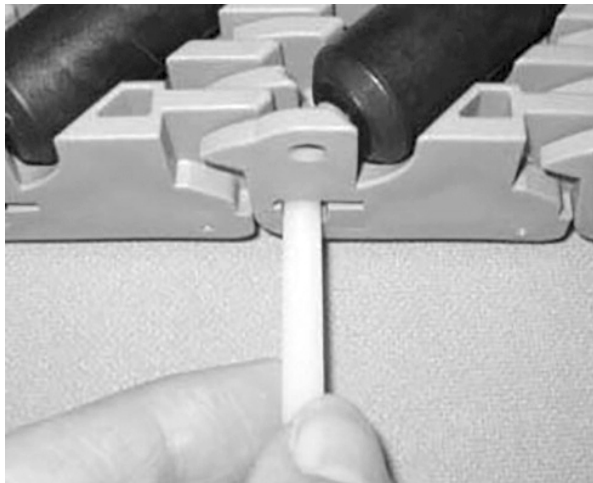

Figure 230: Insert rod through hinges

3. Use a screwdriver to push the rod past the retention feature.

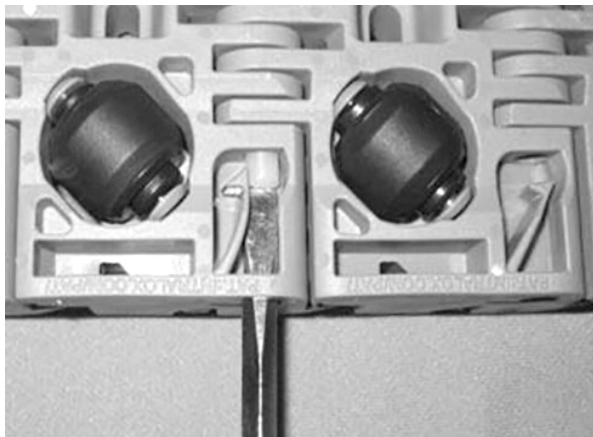

Figure 231: Push rod past retention feature

4. Ensure the rod is fully inserted.

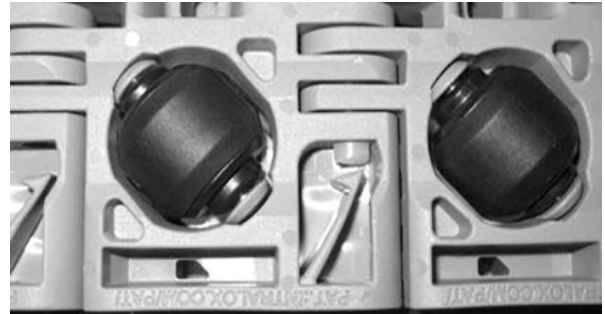

Figure 232: Ensure rod is past retention feature

REMOVE THE ROD

1. On one belt edge, use a screwdriver to push the retention feature open.
2. On the opposite belt edge, use a screwdriver to push the rod out of the belt.

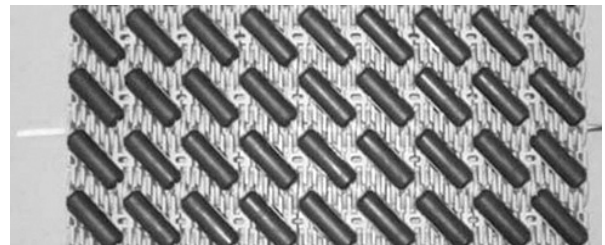
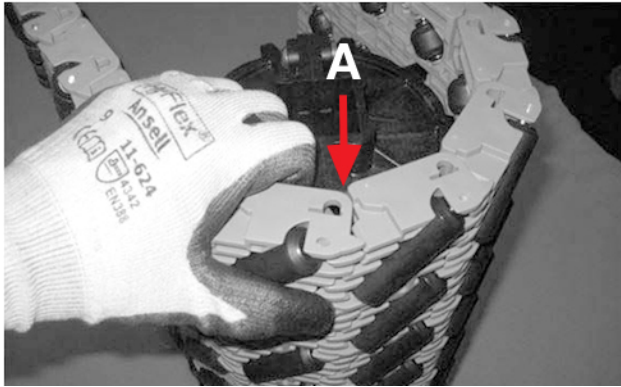

Figure 233: Push rod from belt

BELT HANDLING

The ribs of S4550 DARB are designed to maintain a closed deck as the belt wraps around the sprocket during normal operation. However, the ribs can open up and create a pinch point if it is hinged beyond what is possible with a sprocket. Because of this, wear gloves when handling this belt.



A Closed belt ribs

Figure 234: Normal hinge when wrapped around sprocket

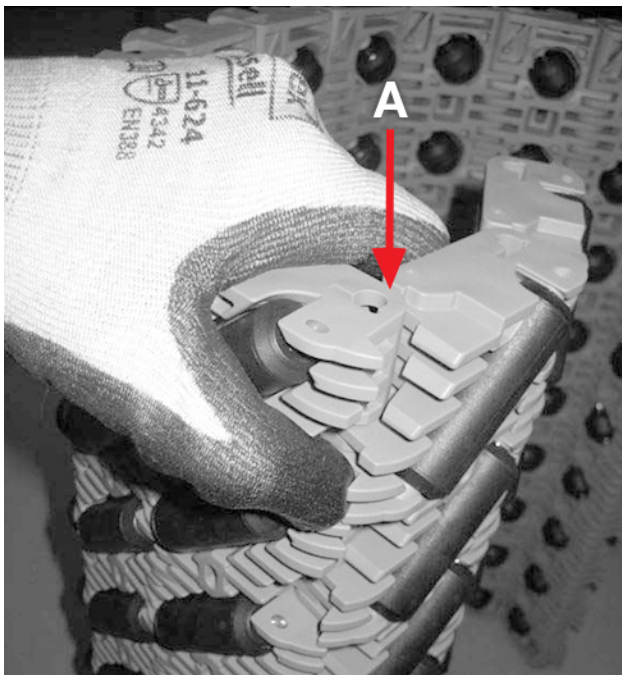

A Opened belt ribs

Figure 235: Exposed pinch point when hinged beyond normal

SERIES 7000-1

BELTS COVERED IN SECTION

- Transverse Roller

NOTE: Before use in food-safe applications, follow good manufacturing practice and thoroughly clean and sanitize belts according to your standard sanitary operating procedures.

UNHEADED ROD

INSERT THE ROD

1. Cut rods 1.75 in (44.5 mm) shorter than the overall belt width.
2. Join belt ends together so the hinges are aligned.
3. Insert the rod through the hinges as far as possible.

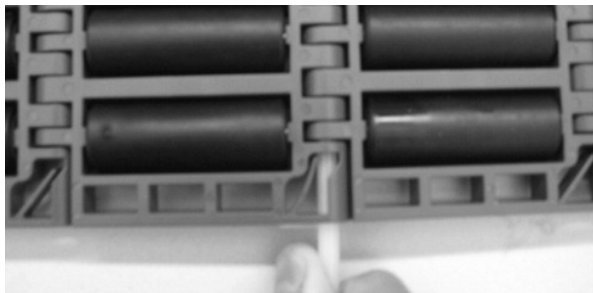

Figure 236: Insert rod through hinges

4. Use a screwdriver to push the rod past the retention feature.

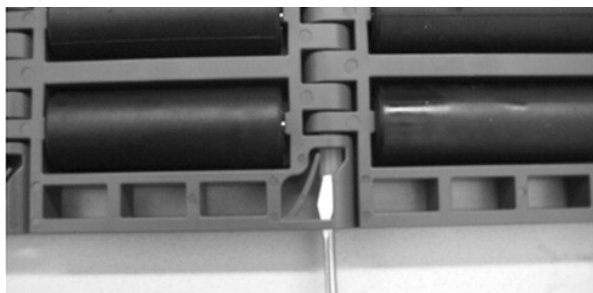

Figure 237: Push rod past retention feature

5. Ensure the rod is fully inserted.

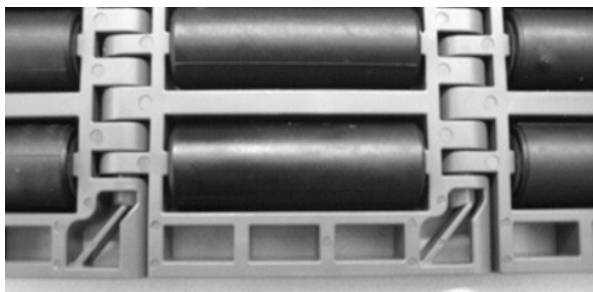

Figure 238: Ensure rod is past retention feature

REMOVE THE ROD

1. On one belt edge, use a screwdriver to push the retention feature open.
2. On the opposite belt edge, use a screwdriver to push the rod out of the belt.



Figure 239: Push rod from belt

SERIES 7050-1

BELTS COVERED IN SECTION

- Dual-Stacked Transverse Roller

NOTE: Before use in food-safe applications, follow good manufacturing practice and thoroughly clean and sanitize belts according to your standard sanitary operating procedures.

UNHEADED ROD

INSERT THE ROD

1. Join belt ends together so the hinges are aligned.
2. Insert the rod through the hinges as far as possible.

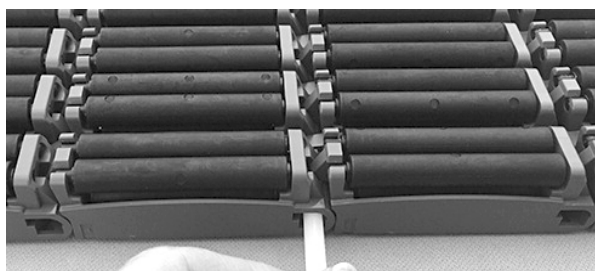

Figure 240: Insert rod through hinges

3. Use a screwdriver to push the rod past the retention feature.

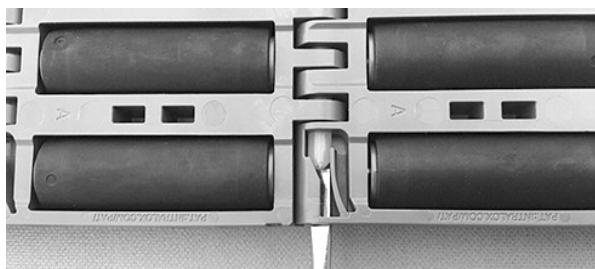

Figure 241: Push rod past retention feature

4. Ensure the rod is fully inserted.

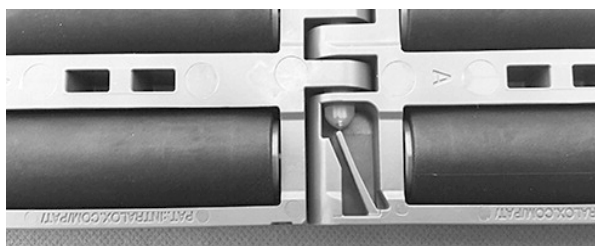

Figure 242: Ensure rod is past retention feature

REMOVE THE ROD

1. On one belt edge, use a screwdriver to push the retention feature open.

2. On the opposite belt edge, use a screwdriver to push the rod out of the belt.

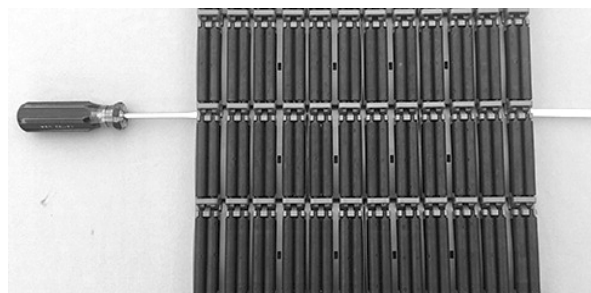
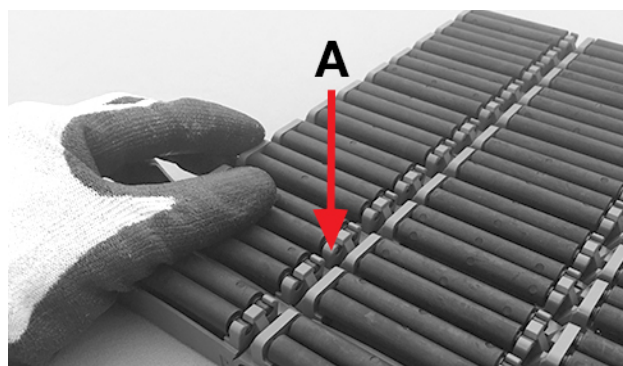

Figure 243: Push rod from belt

BELT HANDLING

The top roller retention features of the S7050 Dual-Stacked TRT belt can create pinch points if the belt backbends. Wear gloves when handling this belt.



A Pinch point

Figure 244: Wear gloves when handling belt

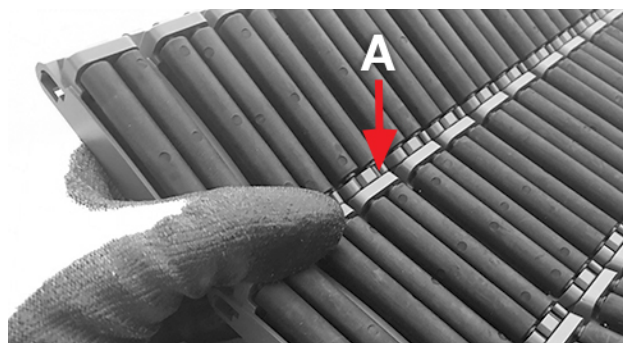

A Pinch point

Figure 245: Pinch points occur if belt backbends

SERIES 9000-1

BELTS COVERED IN SECTION

- Flush Grid

NOTE: Before use in food-safe applications, follow good manufacturing practice and thoroughly clean and sanitize belts according to your standard sanitary operating procedures.

UNHEADED ROD

INSERT THE ROD

1. Join belt ends together so the hinges are aligned.
2. Insert the rod through the hinges as far as possible.

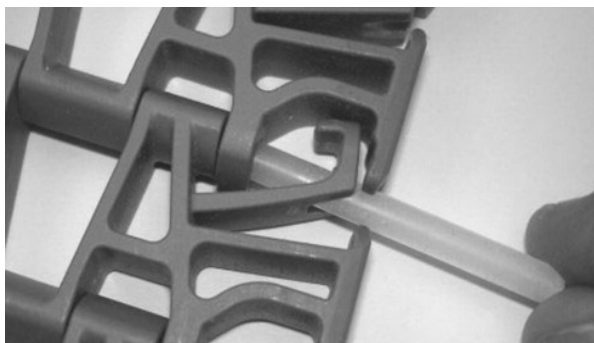

Figure 246: Insert rod through hinges

3. Use a screwdriver to push the rod past the retention feature.

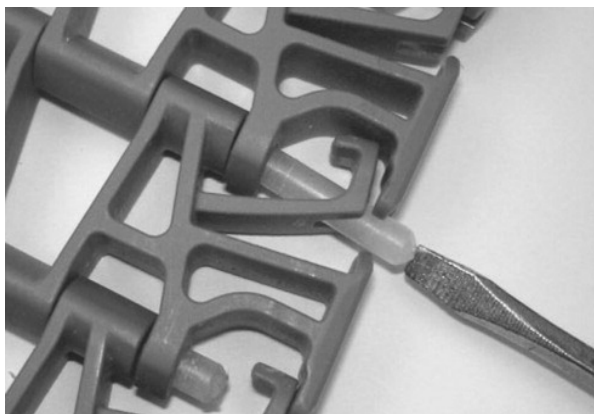

Figure 247: Push rod past retention feature

4. Ensure the rod is fully inserted.



Figure 248: Ensure rod is past retention feature

REMOVE THE ROD

1. From the top of the belt, insert a screwdriver between the retention feature and the belt edge.
2. Rotate the screwdriver clockwise to hold the retention feature open.

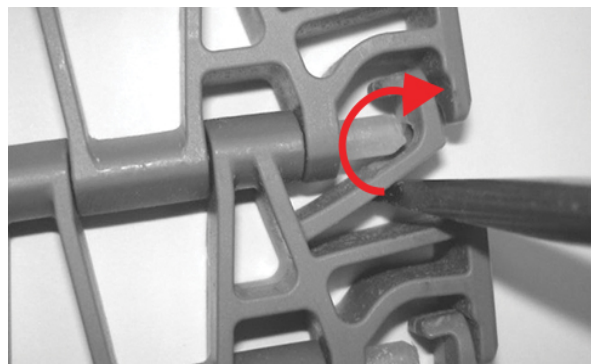

Figure 249: Rotate screwdriver to hold retention feature open

3. On the opposite belt edge, use a screwdriver to push the rod out of the belt.

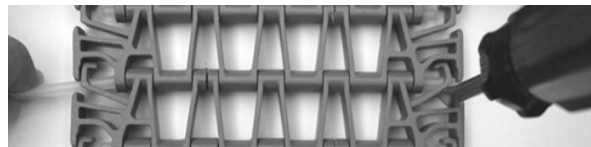

Figure 250: Push rod from belt

SPLICING ORIGINAL DESIGN WITH UPDATED DESIGN

The S9000 Flush Grid design was updated in October 2012 for improved performance.

1. Cut the 0.180 in (4.6 mm) headed rods used in the original belt section 0.75 in (19 mm) shorter than the overall belt width.
2. Bring the two belt sections close together, but do not join them.
3. On the new belt section (B), locate the rod retention features that point toward the original belt section (A).



A Original belt section
B New belt section

Figure 251: Locate the rod retention features

4. Cut off the rod retention feature on both edges of the new belt section (B).



Figure 252: Cut retention feature

5. Join the original belt section (A) with the new belt section (B) so the hinges are aligned.
6. Insert an unheaded rod through the retention feature on the original belt section (A).

7. Use a screwdriver to push the rod past the retention feature.
8. Ensure the rod is fully inserted.



A Original belt section

B New belt section

Figure 253: Ensure rod is fully inserted

9. To close the other end of the belt, join the new section (B) with the original section (A).

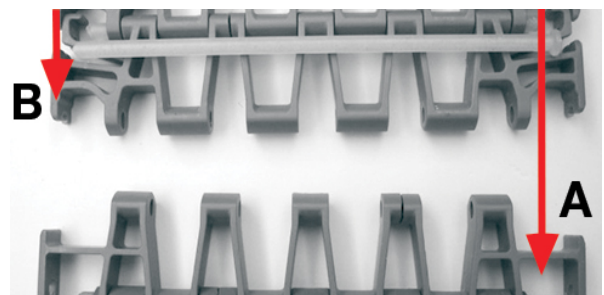

A Original belt section

B New belt section

Figure 254: Join new section (B) with original section (A)

10. Insert a headed rod through the retention feature on the new belt section (B).
11. Use a screwdriver to push the rod past the retention feature on the new belt section (B).
12. Ensure the rod is fully inserted.

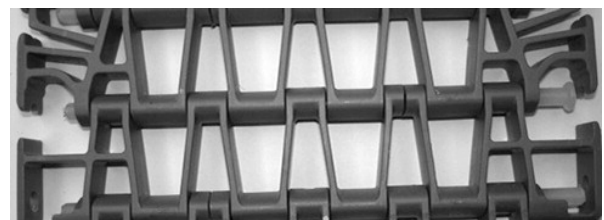

Figure 255: Ensure rod is past retention feature

SPLICING WIDE BELTS

Preformed, headed rods are not always available for wide belts. If needed, the original rods can be headed on both ends to join old and new belt sections.

1. Join belt ends together so the hinges are aligned.
2. Insert the rod through the hinges, leaving the end of the rod protruding.

NOTE: DO NOT use an open flame to close rod holes.

3. Use an 80-watt soldering iron to head the rod. Ensure the finished rod head is about 0.25 in (6.4 mm) in diameter.
4. Ensure all rods are headed on both sides of the belt.

SERIES 10000-1

BELTS COVERED IN SECTION

- Bricklay Flat Top
- Bricklay Non Skid Raised Rib
- Bricklay Non Skid Perforated

NOTE: Before use in food-safe applications, follow good manufacturing practice and thoroughly clean and sanitize belts according to your standard sanitary operating procedures.

UNHEADED ROD AND SLIDELOX RETAINER

INSERT THE ROD

1. On one belt edge, ensure the Slidelox is closed. If not, use a screwdriver to slide the latch to close the Slidelox.



Figure 256: Close Slidelox

2. On the opposite belt edge, ensure the Slidelox is open. If not, use a screwdriver to slide the latch to open the Slidelox.



Figure 257: Open Slidelox

3. Join belt ends together so the hinges are aligned.

4. Insert the rod through the open Slidelox.

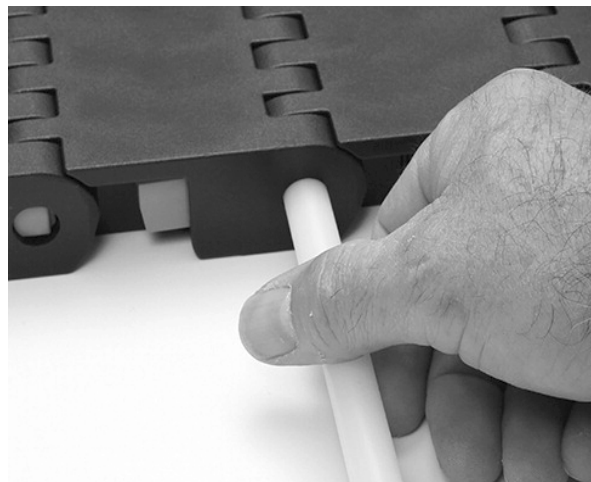

Figure 258: Insert rod

5. Ensure the rod is inserted about 0.5 in (12.7 mm) past the belt edge.
6. Once the rod is inserted, close the Slidelox. The Slidelox snaps when closed.

NOTE: Ensure all Slidelox are closed after installation.

REMOVE THE ROD

NOTE: DO NOT remove Slidelox from edge modules. Removal can destroy the Slidelox and module.

1. Use a screwdriver to open the Slidelox on both belt edges.

SERIES 10000-1

2. Use a screwdriver to push the rod out of the belt.



Figure 259: Push rod from belt

3. Once the rod is removed, use a screwdriver to slide the latch to close the Slidelox. The Slidelox snaps when closed.

NOTE: Ensure ALL Slidelox are closed after installation.

SERIES 10000-2

BELTS COVERED IN SECTION

- Mold to Width (MTW) Flat Top

NOTE: Before use in food-safe applications, follow good manufacturing practice and thoroughly clean and sanitize belts according to your standard sanitary operating procedures.

UNHEADED ROD AND SLIDELOX RETAINER

INSERT THE ROD

1. On the belt edge with the Slidelox, ensure the Slidelox is open. If not, use a screwdriver to slide the latch to open the Slidelox.



Figure 260: Open Slidelox

2. Join belt ends together so the hinges are aligned.
3. Insert the rod through the open Slidelox.



Figure 261: Insert rod

4. Ensure the rod is inserted about 0.5 in (12.7 mm) past the belt edge.

5. Once the rod is inserted, close the Slidelox. The Slidelox snaps when closed.

NOTE: Ensure ALL Slidelox are closed after installation.

REMOVE THE ROD

NOTE: DO NOT remove Slidelox from edge modules. Removal can destroy the Slidelox and module.

1. Use a screwdriver to open the Slidelox.



Figure 262: Open Slidelox

2. On the opposite belt edge, use a screwdriver to push the rod out of the belt.



Figure 263: Push rod from belt

- Once the rod is removed, use a screwdriver to slide the latch to close the Slidex. The Slidex snaps when closed.

NOTE: Ensure ALL Slidex are closed after installation.

100 MM MTW SPROCKET OFFSET

BELT RUN DIRECTION

Use the following information if the Slidex is on the left as the belt moves away from you.

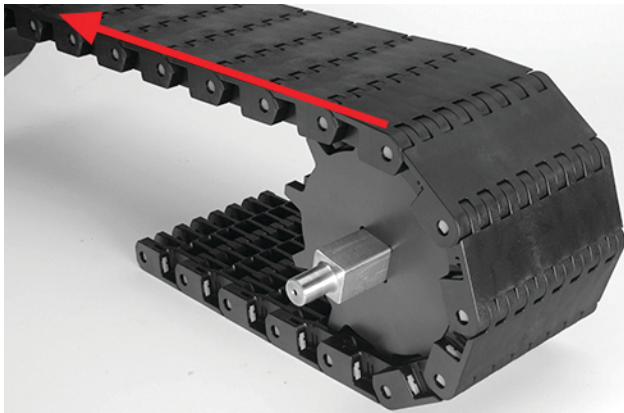

Figure 264: Slidex on left

HINGE DRIVE

Use a maximum of two sprockets with one sprocket centerline offset 0.25 in (6.3 mm) to the left of the chain center.

CENTER DRIVE

One sprocket centerline must be offset 0.25 in (6.3 mm) to the right of the chain center.

BELT RUN DIRECTION

Use the following information if the Slidex is on the right as the belt moves away from you.

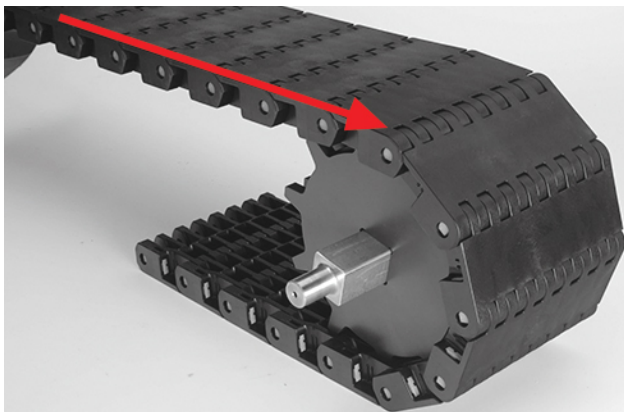

Figure 265: Run direction

HINGE DRIVE

One sprocket centerline must be offset 0.25 in (6.3 mm) to the left of the chain center.

CENTER DRIVE

One sprocket centerline must be offset 0.25 in (6.3 mm) to the right of the chain center.

200 MM MTW SPROCKET OFFSET

BELT RUN DIRECTION

Use the following information if the Slidex is on the left as the belt moves away from you.

HINGE DRIVE

Use a maximum of four sprockets with the center sprocket offset 0.25 in (6.3 mm) to the left of the chain center.

CENTER DRIVE

Use a maximum of three sprockets with the center sprocket offset 0.25 in (6.3 mm) to the right of the chain center.

BELT RUN DIRECTION

Use the following information if the Slidex is on the right as the belt moves away from you.

HINGE DRIVE

Use a maximum of three sprockets with the center sprocket offset 0.25 in (6.3 mm) to the left of the chain center.

CENTER DRIVE

Use a maximum of three sprockets with the center sprocket offset 0.25 in (6.3 mm) to the right of the chain center.

RADIUS BELTS

SERIES 2100-1

BELTS COVERED IN SECTION

- ZERO TANGENT™ Radius Flat Top

NOTE: Before use in food-safe applications, follow good manufacturing practice and thoroughly clean and sanitize belts according to your standard sanitary operating procedures.

UNHEADED ROD

- Ensure rods are the correct length.
- Whenever possible, use the precut rods supplied with the belt. If precut rods are not available, ensure dry nylon rods are cut 3.40 in + belt width/80 in (86.5 mm + belt width/80 mm) shorter than the overall belt width.
- Because wet nylon rods shrink as they dry, do not cut wet nylon rods to length.
- Cut polypropylene or acetal rods 0.50 in (12.7 mm) shorter than the overall belt width.

INSERT THE ROD

1. Join belt ends together so the hinges are aligned.
2. Insert the rod through the hinges as far as possible.

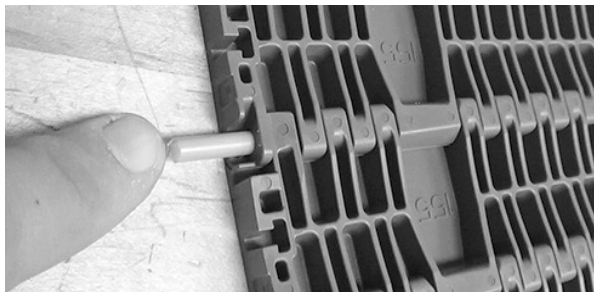

Figure 266: Insert rod

3. Insert the rodlet.
4. Use a screwdriver to push the rodlet past the retention feature and fully into the belt.



Figure 267: Push rodlet past retention feature

5. Ensure the rod is fully inserted.

REMOVE THE ROD

1. From the bottom of the belt, cut off the rodlet heads.

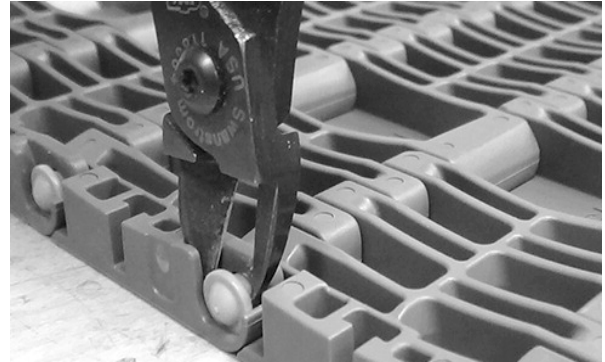

Figure 268: Cut rodlet

2. Use a stiff, 0.9 in (24 mm) diameter wire to push the rodlet and rod out of the belt.



Figure 269: Push rod and rodlet from belt

SERIES 2200-1

BELTS COVERED IN SECTION

- Radius Flush Grid
- Radius Flush Grid High Deck
- Radius Flush Grid (2.6) with Insert Rollers
- Radius Friction Top



This belt can trap and injure fingers. Never touch a moving belt! Stop the conveyor before servicing.

NOTE: Before use in food-safe applications, follow good manufacturing practice and thoroughly clean and sanitize belts according to your standard sanitary operating procedures.

BELT INSTALLATION

- The S2200 (without accessories) is top to bottom reversible, symmetrical, and bi-directional. Please consult an Intralox spiral engineer for the best run direction.
- Hold down wearstrips are mandatory on inside and outside edges of all turns to keep the belt constrained while turning.
- Edge guides must extend at least one belt width into the adjacent straight runs to ensure the belt path is straight before and after each turn.

NOTE: Ensure hold down wearstrips are installed on the inside and outside edges of all turns.

UNHEADED ROD

- S2200 polypropylene and polyethylene belts use 0.24 in (6.1 mm) diameter acetal rods.
- S2200 acetal belts use nylon or acetal rods.
- S2200 polypropylene belts for chemical resistance use polypropylene rods.
- Extra rods are packed with each belt.

INSERT THE ROD

1. Cut rods 0.44 in (11 mm) shorter than the overall belt width.
2. Join belt ends together so the hinges are aligned.
3. Insert the rod through the hinges as far as possible.

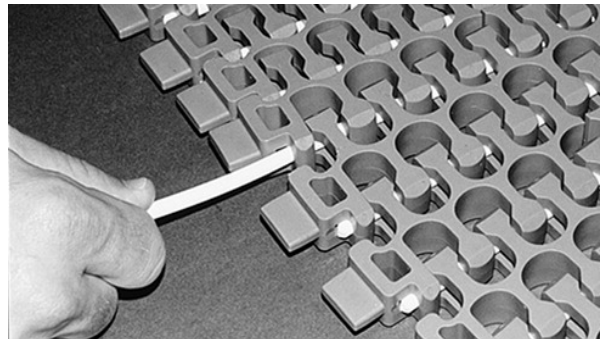

Figure 270: Insert rod

4. Use a screwdriver to push the rod past the retention feature.



Figure 271: Ensure rod is past retention feature

5. Ensure the rod is fully inserted.

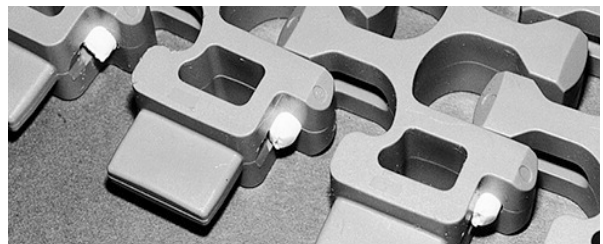

Figure 272: Ensure rod is fully inserted

REMOVE THE ROD

1. Use your thumb to flex the flush edge of the module to free the rod from the retention feature.



Figure 273: Free rod from retention feature

2. Grip and pull the rod out to open the belt.



Figure 274: Grip rod

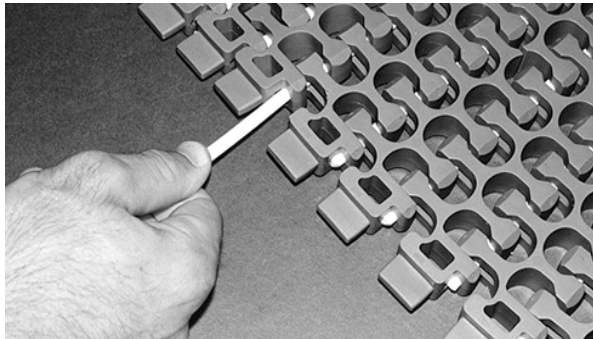
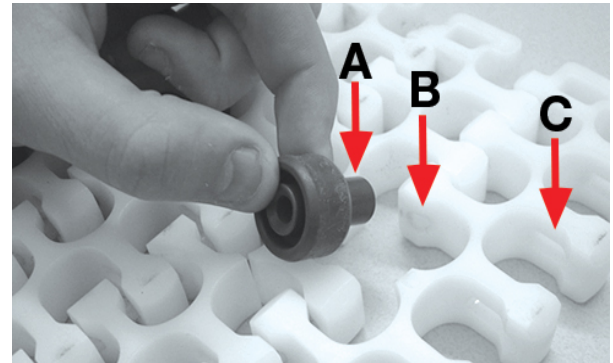

Figure 275: Pull out rod

S2200 WITH INSERT ROLLERS

- Ensure the rollers are retained for reinsertion when rods are removed.
- Ensure the side of the Insert Roller with the smaller diameter is next to the link with a round rod hole, not a slotted hole. Incorrect roller placement affects turn ratio.



- A** Small diameter
- B** Round rod hole
- C** Slotted hole

Figure 276: Smaller diameter next to round rod hole

- Ensure all Insert Rollers are positioned so the sides with the small diameters are oriented in the same direction when splicing together two or more belt sections. Rollers oriented in opposite directions can interfere with sprockets.
- Ensure the Insert Rollers contact the wearstrips during belt installation. If your conveyor is designed to your belt specifications, but the Insert Rollers do not contact the carryway, flip the belt.

SERIES 2200-2

BELTS COVERED IN SECTION

- Radius with Edge Bearing
- Radius Flush Grid High Deck with Edge Bearing



This belt can trap and injure fingers. Never touch a moving belt! Stop the conveyor before servicing.

NOTE: Before use in food-safe applications, follow good manufacturing practice and thoroughly clean and sanitize belts according to your standard sanitary operating procedures.

BELT RUN DIRECTION

The S2200 Radius/High Deck with Edge Bearing (without accessories) is top to bottom reversible. The recommended run direction is illustrated here.

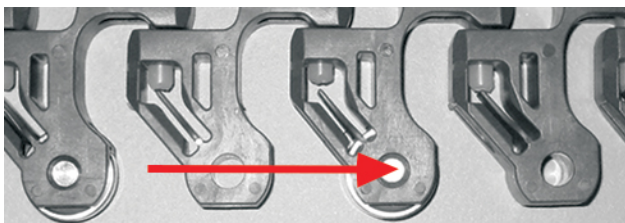

Figure 277: Run direction

UNHEADED ROD

INSERT THE ROD

1. Join belt ends together so the hinges are aligned.
2. Insert the rod through the hinges as far as possible.
3. Use a screwdriver to push the rod past the retention feature.



Figure 278: Push rod past retention feature

4. Ensure the rod is fully inserted.

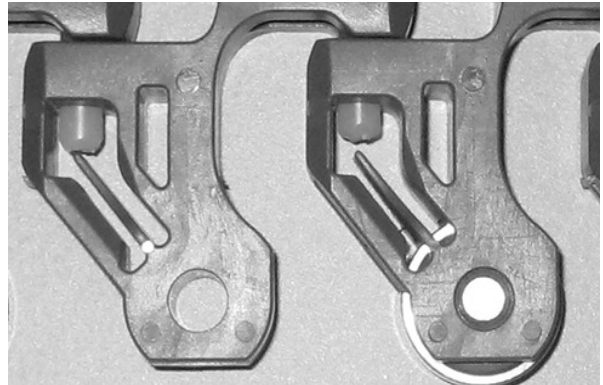

Figure 279: Ensure rod is past retention feature

REMOVE THE ROD

1. On one belt edge, use a screwdriver to push the retention feature open.

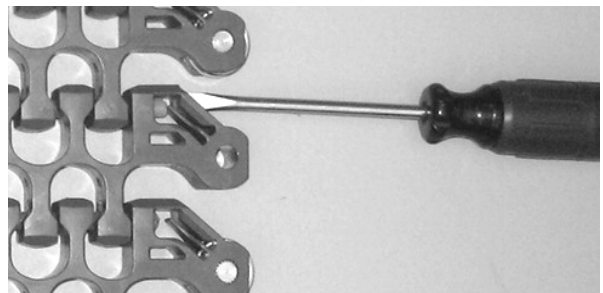

Figure 280: Open retention feature

2. On the opposite belt edge, use a screwdriver to push the rod out of the belt.



Figure 281: Push rod from belt

SERIES 2300-1

BELTS COVERED IN SECTION

- Flush Grid Nose-Roller Tight Turning
- Flush Grid Nose-Roller Tight Turning with Edge Bearing

NOTE: Before use in food-safe applications, follow good manufacturing practice and thoroughly clean and sanitize belts according to your standard sanitary operating procedures.

UNHEADED ROD

- Ensure rods are the correct length.
- Whenever possible, use the precut rods supplied with the belt.

INSERT THE ROD

1. Join belt ends together so the hinges are aligned.
2. Insert the rod through the hinges as far as possible.

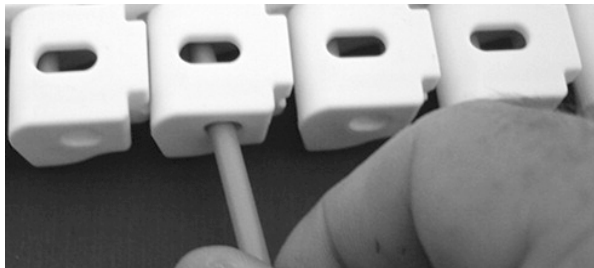

Figure 282: Insert rod through hinges

3. Use a screwdriver to push the rod past the retention feature.



Figure 283: Push rod past retention feature

4. Ensure the rod is fully inserted.



Figure 284: Ensure rod is past retention feature

REMOVE THE ROD

1. From the top of the belt, insert a screwdriver between the rod and the belt.
2. Twist the screwdriver to bend and push the rod through the retention feature and out of the belt.



Figure 285: Push rod through retention feature

3. Once past the belt edge, pull the rod out to open the belt.

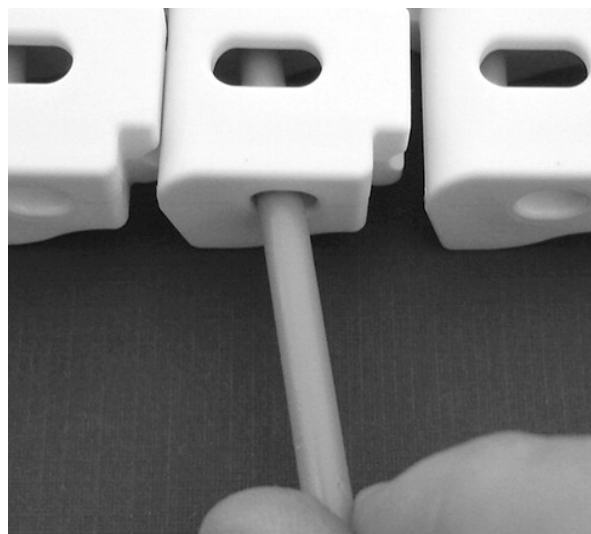

Figure 286: Pull rod from belt

SERIES 2400-1

BELTS COVERED IN SECTION

- Radius Flat Top
- Radius Flush Grid (1.7 and 2.2)
- Radius Flush Grid (2.4 and 2.8) with Insert Rollers
- Radius Flush Grid High Deck
- Flush Grid High Deck with Load-Sharing Edge
- Radius Flush Grid with Load-Sharing Edge
- Radius Friction Top (2.2)
- Radius Flush Grid Friction Top 2.2 with Load-Sharing Edge
- Radius Raised Rib
- 0.4 in High Radius Friction Top

NOTE: Before use in food-safe applications, follow good manufacturing practice and thoroughly clean and sanitize belts according to your standard sanitary operating procedures.

BELT INSTALLATION

- The S2400 (without flights, friction modules or hold down guides) is top to bottom reversible, symmetrical, and bi-directional. Please consult an Intralox spiral engineer for the best run direction.
- Hold down wearstrips are mandatory on inside and outside edges of all turns to keep the belt constrained while turning.
- Edge guides must extend at least one belt width into the adjacent straight runs to ensure the belt path is straight before and after each turn.

NOTE: Ensure hold down wearstrips are installed on the inside and outside edges of all turns.

UNHEADED RODS

- S2400 polypropylene belts use 0.180 in (4.6 mm) diameter acetal rods.
- For chemical resistance on polypropylene belts, use polypropylene rods.
- Extra rods are packed with each belt.

INSERT THE ROD

1. Cut rods 0.6 in (15 mm) shorter than the overall belt width.
2. Join belt ends together so the hinges are aligned.

3. Insert the rod through the hinges as far as possible.

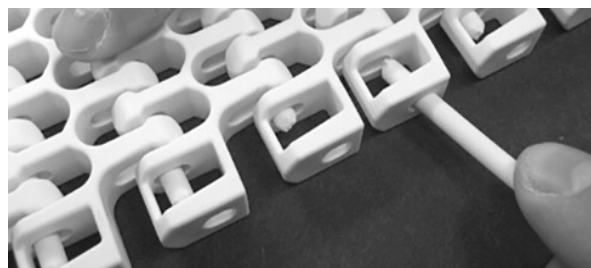

Figure 287: Insert rod through hinges

4. Use a screwdriver to push the rod past the retention feature.

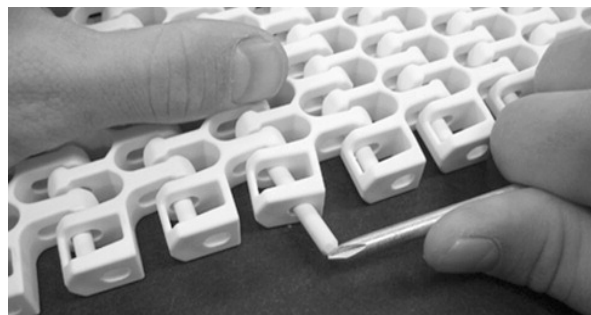

Figure 288: Push rod past retention feature

5. Ensure the rod is fully inserted.

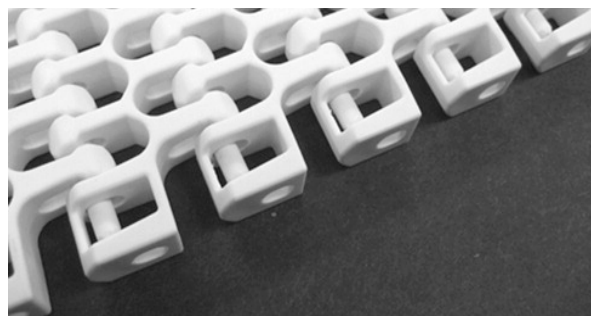

Figure 289: Ensure rod is past retention feature

REMOVE THE ROD

1. From the top of the belt, insert a screwdriver between the rod and the belt.

SERIES 2400-1

2. Twist the screwdriver to bend and push the rod through the retention feature and out of the belt.

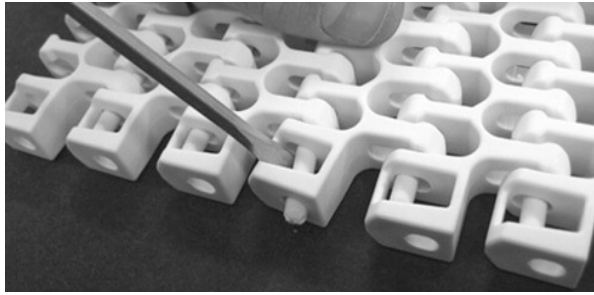

Figure 290: Push rod through retention feature

3. Once past the belt edge, pull the rod out to open the belt.

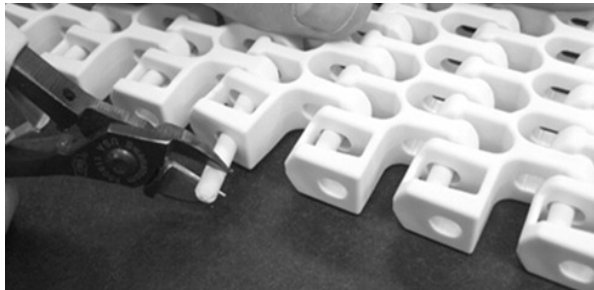
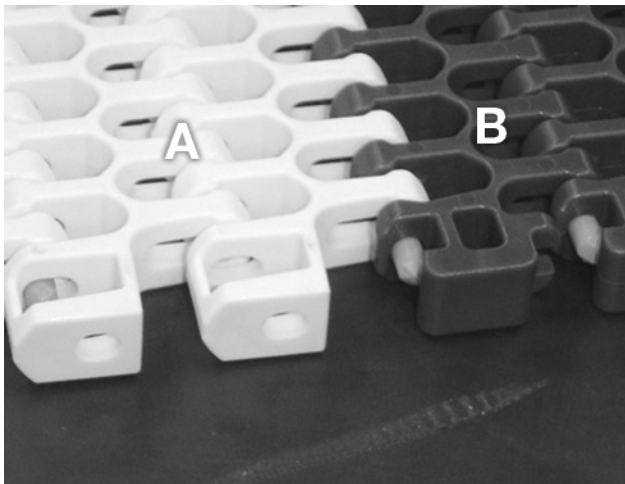

Figure 291: Pull rod from belt

SPLICING NEW FLUSH EDGE (A) WITH OLD FLUSH EDGE (B)

When connecting the leading edge of the new flush edge design (A) to the trailing edge of the old flush edge design (B), no modifications are necessary.



- A New Flush Edge
- B Old Flush Edge

Figure 292: Leading edge A spliced with trailing edge B

When connecting the leading edge of the old flush edge design (B) to the trailing edge of the new flush edge design (A), modification of the old design (B) is necessary.

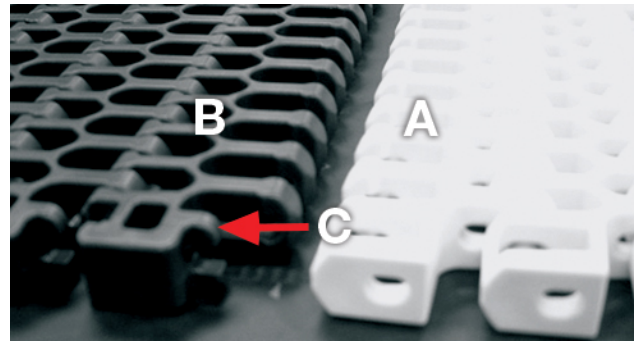

- A New Flush Edge
- B Old Flush Edge
- C Rod guides

Figure 293: Leading edge B spliced with trailing edge A

1. Use snips to trim the rod guides from the old design module (B).

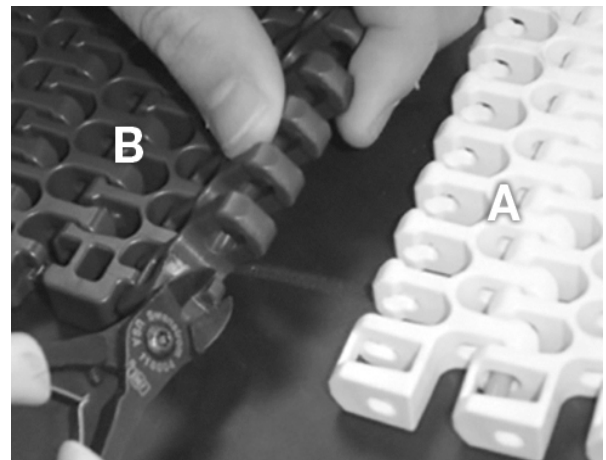

- A New Flush Edge
- B Old Flush Edge

Figure 294: Trim rod guides from old design module (B)

2. Once cut, ensure the cut surface is smooth.

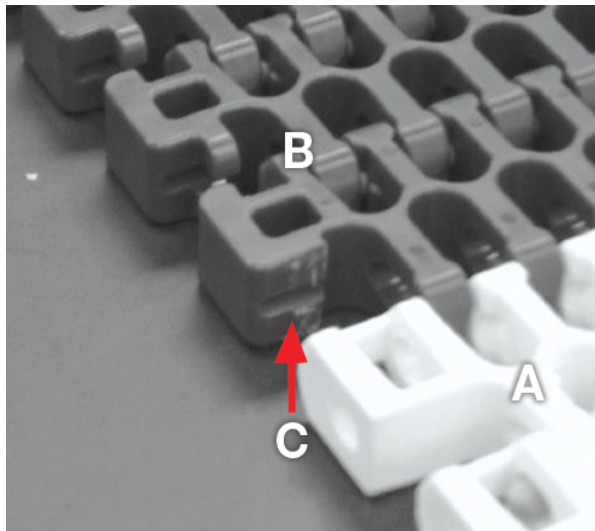

- A New Flush Edge
- B Old Flush Edge
- C Cut surface

Figure 295: Ensure cut surface is smooth

3. See [Insert the Rod](#) for splicing instructions.

S2400 WITH INSERT ROLLERS

- Ensure the rollers are retained for reinsertion when rods are removed.
- Ensure the side of the Insert Roller with the smaller diameter is next to the link with a round rod hole, not a slotted hole, when replacing an Insert Roller. Incorrect roller placement affects turn ratio.

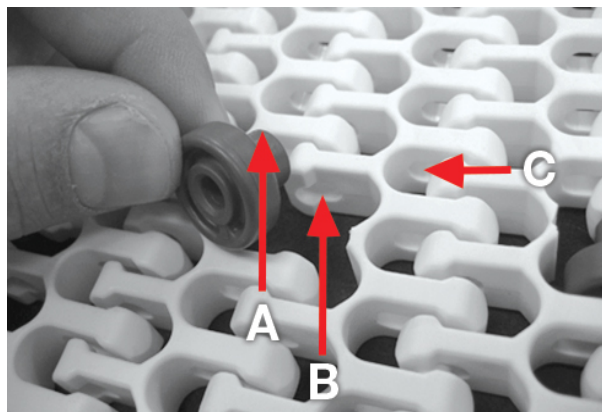

- A Smaller diameter
- B Round rod hole
- C Slotted hole

Figure 296: Smaller diameter next to round rod hole

- Ensure all Insert Rollers are positioned so the sides with the small diameters are oriented in the same direction when splicing together two or more belt sections. Rollers oriented in opposite directions can interfere with sprockets.
- Ensure the Insert Rollers contact the wearstrips during belt installation. If your conveyor is designed to your belt specifications, but the Insert Rollers do not contact the carryway, flip the belt.

SERIES 2400-2

BELTS COVERED IN SECTION

- Radius with Edge Bearing
- Flush Grid High Deck with Edge Bearing

NOTE: Before use in food-safe applications, follow good manufacturing practice and thoroughly clean and sanitize belts according to your standard sanitary operating procedures.

BELT RUN DIRECTION

The S2400 Radius with Edge Bearing (without accessories) is top to bottom reversible. The recommended run direction is illustrated here.

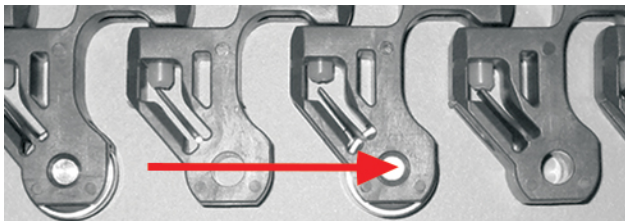

Figure 297: S2400 Radius with Edge Bearing

UNHEADED ROD

REMOVE THE ROD

1. On one belt edge, use a screwdriver to push the retention feature open.

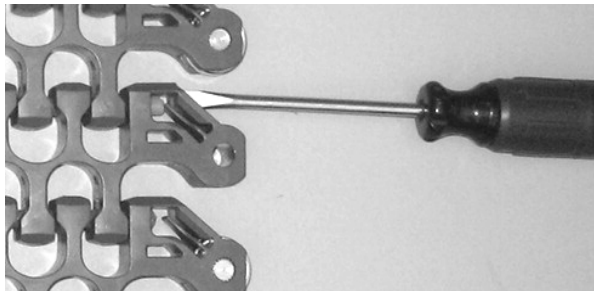

Figure 298: Open retention feature

2. On the opposite belt edge, use a screwdriver to push the rod out of the belt.

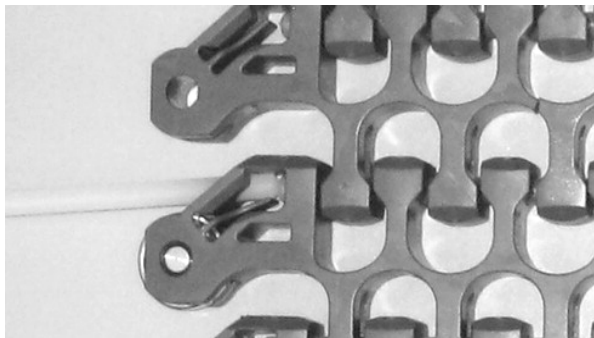

Figure 299: Pull rod from belt

INSERT THE ROD

1. Join belt ends together so the hinges are aligned.
2. Insert the rod through the hinges as far as possible.
3. Use a screwdriver to push the rod past the retention feature.



Figure 300: Push rod past retention feature

4. Ensure the rod is fully inserted.

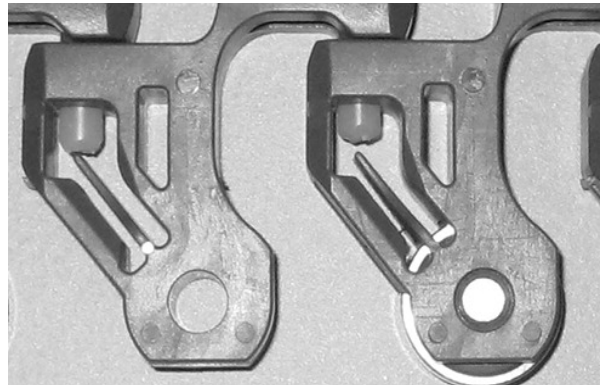

Figure 301: Ensure rod is past retention feature

SERIES 3000-1

BELTS COVERED IN SECTION

- Knuckle Chain
- Mesh Top

NOTE: Before use in food-safe applications, follow good manufacturing practice and thoroughly clean and sanitize belts according to your standard sanitary operating procedures.

STEEL PIN

S3000 chain-style belts are bi-directional. The straight chain, S3000S, is also reversible top-to-bottom.

INSERT THE PIN

1. Join belt ends together so the hinges are aligned.
2. Insert a steel pin through the hinges (smooth end first) and push it through both modules as far as possible (usually up to the knurled end).
3. Use a small hammer or similar tool to tap the knurled end of the pin into the module.
4. Ensure the edges of the pin are at least flush with the edges of the belt. Preferably, the pin is slightly recessed from both sides of the belt.

REMOVE THE PIN

1. Locate the knurled end of the pin. The knurl leaves small grooves in the module when inserted.
2. From the side of the belt opposite the knurl, use a hammer and punch to tap the smooth end of the pin and push the pin from the module.

NOTE: Bent pins prevent the belt from properly fitting on the sprockets.

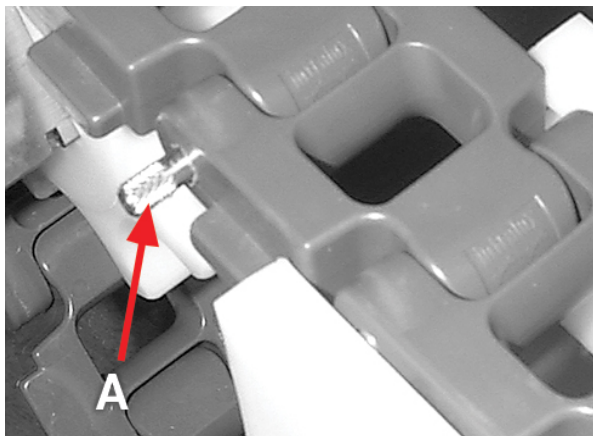

A Knurled end

Figure 302: push pin from module

SECTION REPLACEMENT

- If only repairing a small belt section, it is easiest to remove the belt from the conveyor and remove the pins on either side of the damaged section.
- New belt sections can be spliced into older sections.
- If the belt is caught or snagged on the frame or other object, the steel pins may bend. Though not easily visible, a belt running with bent pins may not fit on the sprockets, causing drive problems.
- If bent pins are found, large belt sections may be damaged and the entire belt may need replacement.

NOTE: Hold down wearstrips are mandatory on the inside and outside edges of all turns to keep the belt constrained while turning.

SERIES 4000-1

BELTS COVERED IN SECTION

- S4009 Flat Top
- S4009 Flush Grid
- S4014 Flat Top
- S4030 7.5-in ProTrax Sideflexing Flat Top with Tabs
- S4031 7.5-in ProTrax Sideflexing Flat Top with Tabs
- S4032 7.5-in ProTrax Sideflexing Flat Top with Tabs
- S4033 7.5-in ProTrax Sideflexing Flat Top
- S4090 Sideflexing Flat Top
- S4091 Sideflexing Flat Top
- S4092 Sideflexing Flat Top
- S4092 Sideflexing Square Friction Top

NOTE: Before use in food-safe applications, follow good manufacturing practice and thoroughly clean and sanitize belts according to your standard sanitary operating procedures.

STEEL PIN

S4000 chain-style belts are designed to run in one direction, indicated by a small arrow on the bottom of the module. While the belt can run in the reverse direction, snagging can occur. The steel pins connecting the modules are press fit into the modules.

NOTE: Only insert pins from the direction indicated on the bottom of the module.

INSERT THE PIN

1. Join belt ends together so the hinges are aligned.
2. Insert a steel pin through the hinges (smooth end first) and push it through both modules as far as possible (usually up to the knurled end).

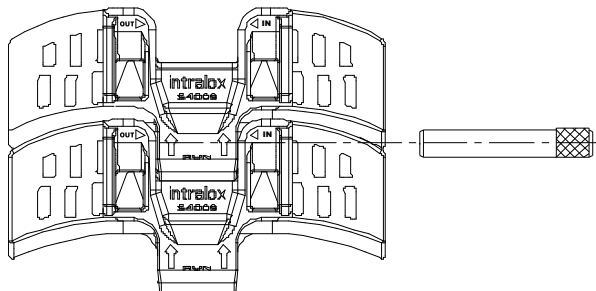

Figure 303: Insert steel pin through hinges

3. Use a small hammer or similar tool to tap the knurled end of the pin into the module.
4. Ensure the edges of the pin are at least flush with the edges of the belt. Preferably, the pin is slightly recessed from both sides of the belt.

REMOVE THE PIN

1. Locate the knurled end of the pin. The knurl leaves small grooves in the module when inserted.
2. From the side of the belt opposite the knurl, use a hammer and punch to tap the smooth end of the pin and push the pin from the module.

NOTE: Pin removal wears down the hinge plastic. DO NOT remove the same pin repeatedly.

SECTION REPLACEMENT

- If only repairing a small belt section, it is easiest to remove the belt from the conveyor and remove the pins on either side of the damaged section.
- New belt sections can be spliced into older sections.
- If the belt is caught or snagged on the frame or other object, the steel pins may bend. Though not easily visible, a belt running with bent pins may not fit on the sprockets, causing drive problems.
- If bent pins are found, large belt sections may be damaged and the entire belt may need replacement.

NOTE: Hold down wearstrips are mandatory on the inside and outside edges of all turns to keep the belt constrained while turning.

SPIRAL BELTS

SERIES 2600-1

BELTS COVERED IN SECTION

- Spiral (1.0, 1.1, 1.6, 2.0, 2.2, 2.5, and 3.2) Radius
- Spiral Rounded Friction Top



This belt can trap and injure fingers. Never touch a moving belt! Stop the conveyor before servicing.

NOTE: Before use in food-safe applications, follow good manufacturing practice and thoroughly clean and sanitize belts according to your standard sanitary operating procedures.

UNHEADED ROD

INSERT THE ROD

1. Ensure the rods are 0.240 in (6 mm) diameter acetal rods.
2. Cut rods 0.5 in (12.7 mm) shorter than the overall belt width.
3. Join belt ends together so the hinges are aligned.
4. Insert the rod through the hinges as far as possible.

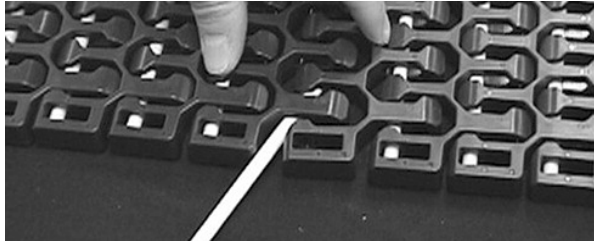

Figure 304: Insert rod through hinges

5. Align the hinges of the fourth and fifth link.

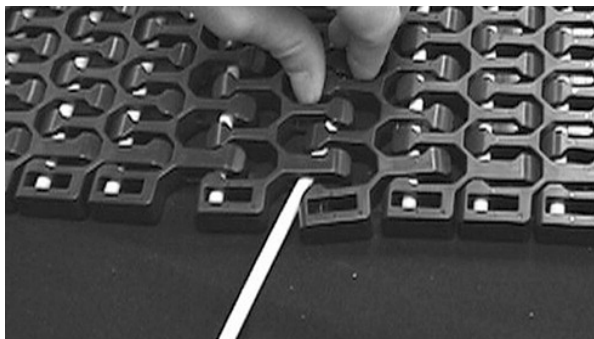

Figure 305: Align hinges

6. Continue inserting the rod through the hinges until the end of rod is near the belt edge.

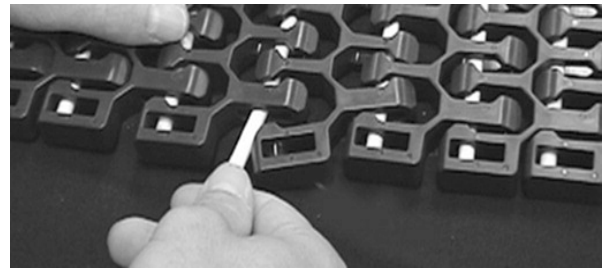

Figure 306: Insert rod through hinges

7. Push the rod past the belt edge and snap the flush edge over the rod into the closed position.



Figure 307: Push rod past belt edge, snap flush edge over rod

8. Ensure the rod is fully inserted.



Figure 308: Ensure the rod is fully inserted

REMOVE THE ROD

1. Grip the rod and push it into the belt.

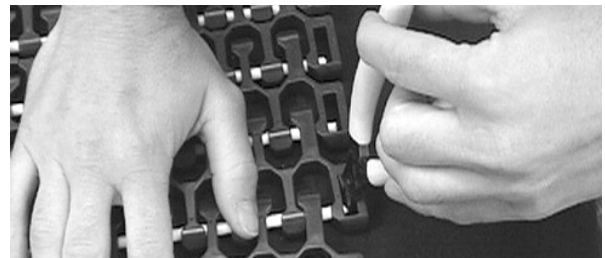

Figure 309: Push rod into belt

2. Use your thumb to flex the flush edge of the module to free the rod from the retention feature.

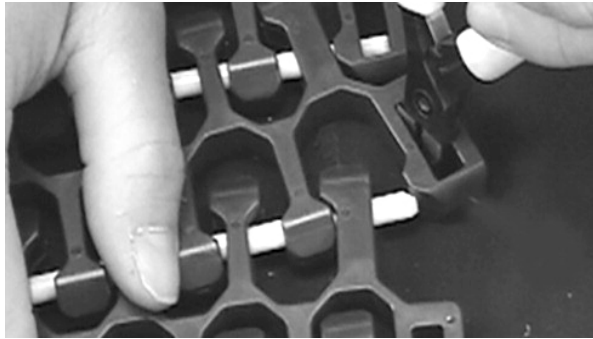

Figure 310: Flex flush edge of module to free rod

3. Grip and pull the rod out to open the belt.

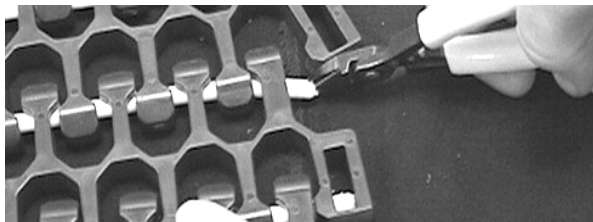

Figure 311: Grip rod

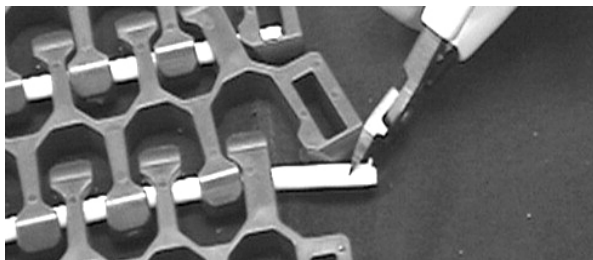

Figure 312: Pull rod from belt

4. Replace rods that show signs of damage or wear.

S2600 OUTER EDGE & DUAL TURNING 2.0

INSERT THE ROD

1. Ensure the rods are 0.240 in (6 mm) diameter acetal rods.
2. Join belt ends together so the hinges are aligned.
3. Insert the rod into the occluded hole.

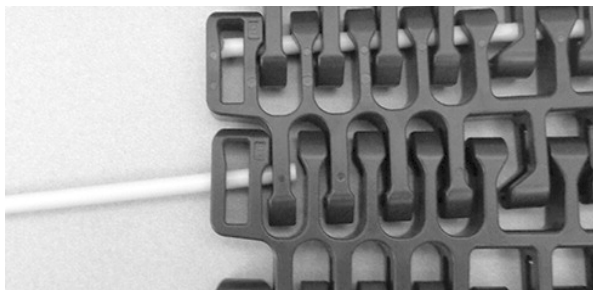

Figure 313: Insert rod

4. While holding the links together to keep the hinges aligned, insert the rod through the hinges as far as possible.

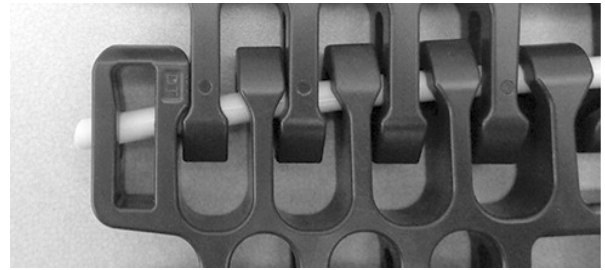

Figure 314: Push rod past retention feature

5. Use a screwdriver to push the rod past the retention feature.
6. Ensure the rod is fully inserted.

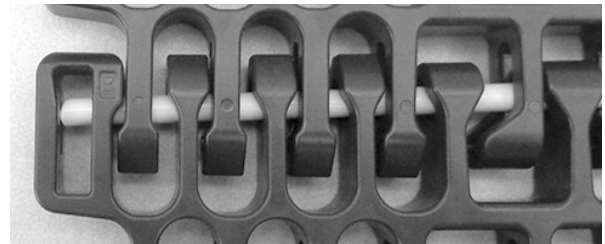

Figure 315: Ensure rod is past retention feature

REMOVE THE ROD

1. Grip the rod in the opening near the belt edge.
2. Push the rod slightly to the side and past the occluded hole.



Figure 316: Push rod to side and past hole

- Once past the belt edge, pull the rod out to open the belt.

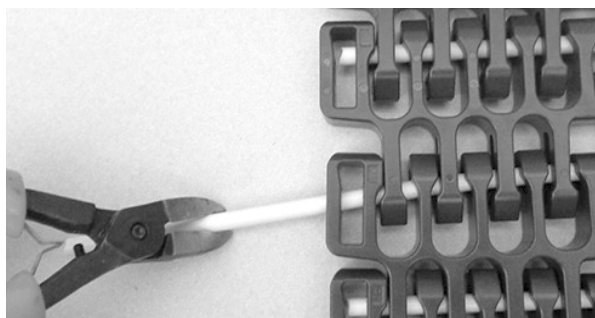

Figure 317: Pull rod from belt

SPIRAL SPROCKET INSTALLATION

- Mount the sprockets on the primary drive shaft so they are evenly distributed, with all sprocket teeth aligned in the same direction when looking down the shaft.
- Ensure all sprocket alignment notches are aligned down the length of the shaft. See [Sprocket Installation in Equipment Installation Overview](#).
- Ensure the outer sprockets adhere to the following minimum sprocket indents:
 - S2600 1.6, 2.2, 2.5, 3.2 turn radius: 4.75 in (120.7 mm) indent from inner & outer belting edge
 - S2600 1.0 turn radius: 12.0 in (304.8 mm) indent from inner edge and 4.75 in (120.7 mm) indent from outer edge.
 - S2600 1.1 turn radius: 9.0 in (228.6 mm) indent from inner edge and 4.75 in (120.7 mm) indent from outer edge.
- Install two support rollers on the inner and outer belt edges. For 1.1 turn radius, a minimum of two support rollers are recommended to be locked down approximately 2 in (50.8 mm) and 6 in (152.4 mm) from the inside edge.

- Secure both sides of all sprockets using the stainless steel split collar retainer rings.



Figure 318: Secure both sides of all sprockets

- Ensure the sprockets properly engage the belt and allow belting to find its natural path.

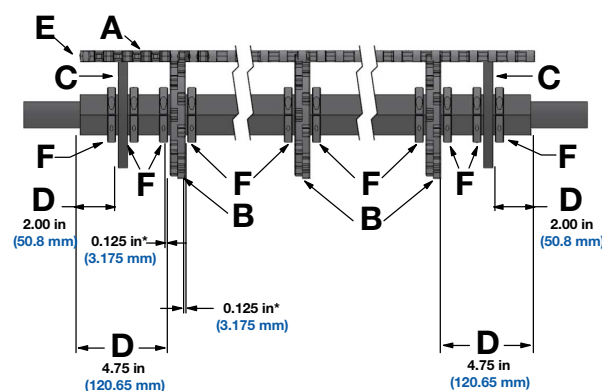

- A Belt
- B Sprocket
- C Support wheel
- D Sprocket indent
- E Inside edge of belt
- F Split heavy-duty retainer ring
- * Typical

SERIES 2600-1

NOTE: All sprockets and support wheels require split heavy-duty retainer rings.

Figure 319: S2600-1.6, 2.2, 2.5, 3.2

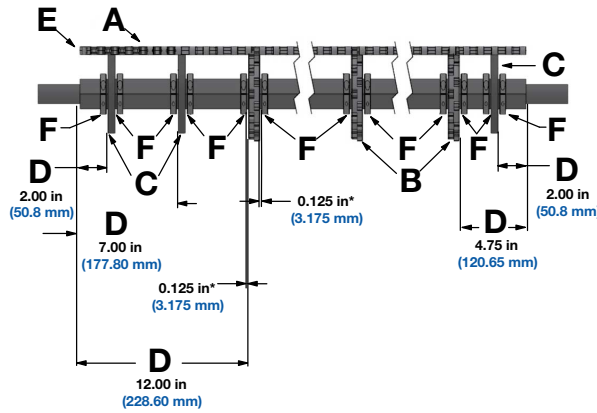

- A Belt
- B Sprocket
- C Support wheel
- D Sprocket indent
- E Inside edge of belt
- F Split heavy-duty retainer ring
- * Typical

NOTE: All sprockets and support wheels require split heavy-duty retainer rings.

Figure 320: S2600-1.0 > = 26 in (660.4 mm)

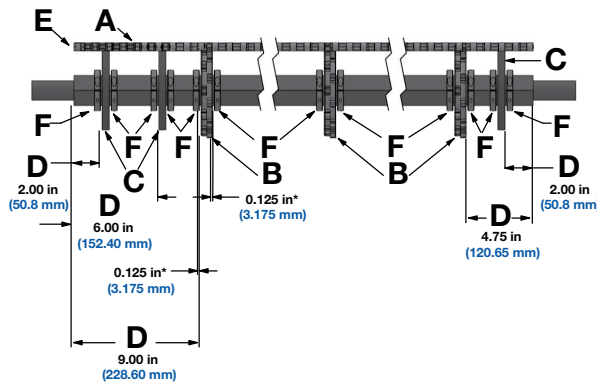

- A Belt
- B Sprocket
- C Support wheel
- D Sprocket indent
- E Inside edge of belt
- F Split heavy-duty retainer ring
- * Typical

NOTE: All sprockets and support wheels require split heavy-duty retainer rings.

Figure 321: S2600-1.1 > =26 in (660.4 mm)

SPIRAL TRAVEL DIRECTION

Spiral belts can run bi-directionally. Please consult an Intralox spiral engineer for the best run direction.

Intralox makes the appropriate belt travel recommendation (Slots Leading or Holes Leading) based on every spiral system design criteria.

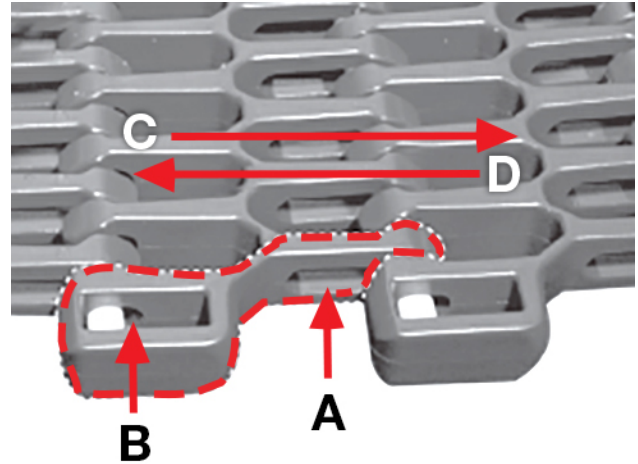

- A Slot
- B Hole
- C Slot leading direction
- D Hole leading direction

Figure 322: Spiral travel direction

SERIES 2700-1

BELTS COVERED IN SECTION

- Spiral (1.6, 2.2, and 2.7) Radius
- Spiral Rounded Friction Top
- Side Drive



This belt can trap and injure fingers. Never touch a moving belt! Stop the conveyor before servicing.

NOTE: Before use in food-safe applications, follow good manufacturing practice and thoroughly clean and sanitize belts according to your standard sanitary operating procedures.

UNHEADED ROD

INSERT THE ROD

1. Ensure the rods are 0.240 in (6 mm) diameter acetal rods.
2. Cut rods 0.5 in (12.7 mm) shorter than the overall belt width.
3. Join belt ends together so the hinges are aligned.
4. Insert the rod through the hinges as far as possible.

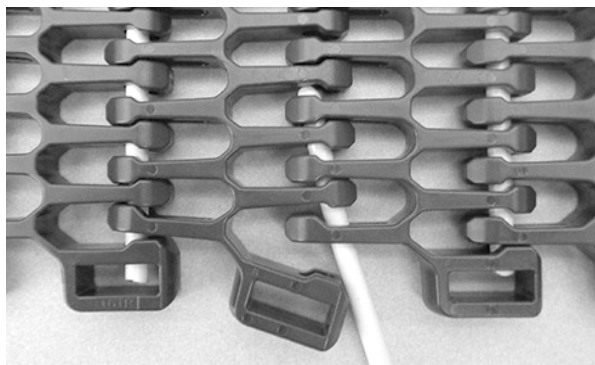

Figure 323: Insert rod through hinges

5. Align the hinges of the fourth and fifth link.

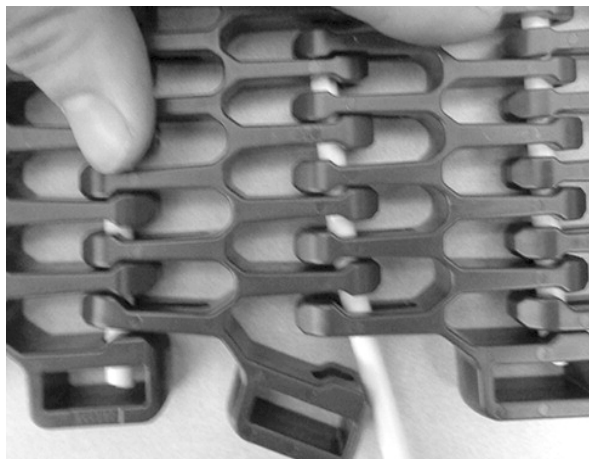

Figure 324: Align hinges

6. Continue inserting the rod through the hinges until the end of rod is near the belt edge.
7. Push the rod past the belt edge and snap the flush edge over the rod into the closed position.

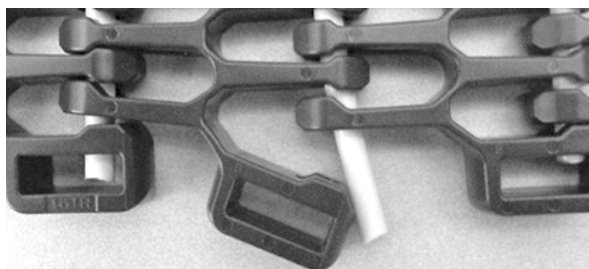

Figure 325: Push rod past belt edge

8. Ensure the rod is fully inserted.

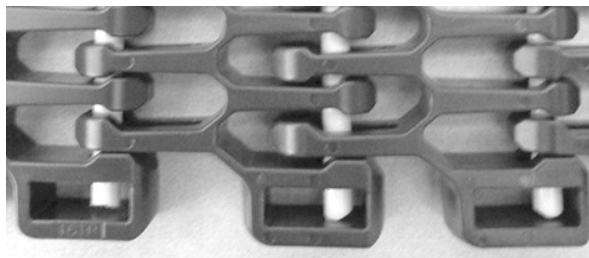

Figure 326: Ensure rod is fully inserted

REMOVE THE ROD

1. Grip the rod and push it into the belt.
2. Use your thumb to flex the flush edge of the module to free the rod from the retention feature.

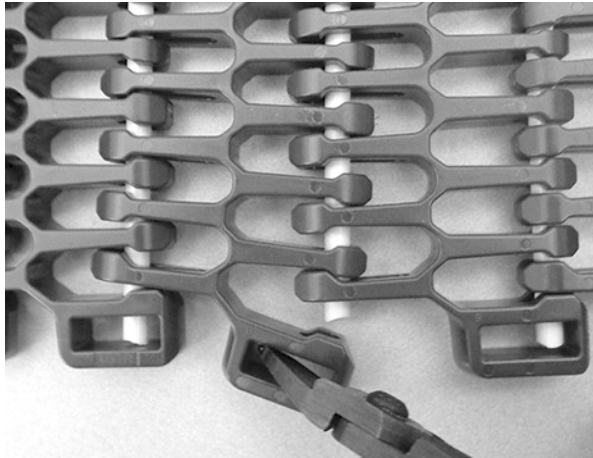

Figure 327: Flex flush edge of module

3. Grip and pull the rod out to open the belt.



Figure 328: Grip rod

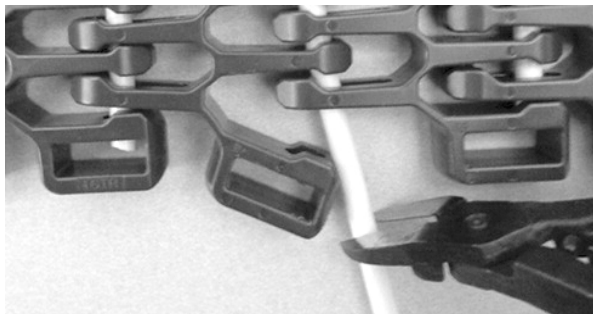

Figure 329: Pull rod from belt

S2700 2.2/2.7 RADIUS WITH OCCLUDED HOLES ON THE FLUSH EDGE

INSERT THE ROD

NOTE: S2700 DirectDrive™ requires all rod insertion to occur on the outside belt edge.

1. Ensure the rods are 0.240 in (6 mm) diameter acetal rods.
2. Join belt ends together so the hinges are aligned.
3. Insert the rod into the occluded hole.

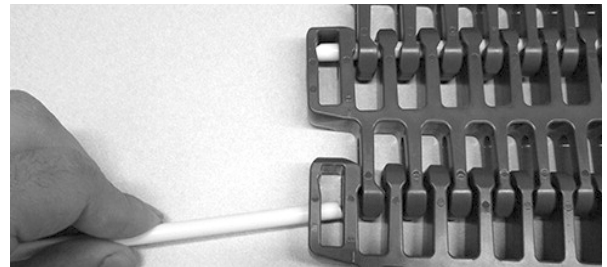

Figure 330: Insert rod

4. While holding the links together to keep the hinges aligned, insert the rod through the hinges as far as possible.



Figure 331: Insert rod through hinges

5. Use a screwdriver to push the rod past the retention feature.
6. Ensure the rod is fully inserted.

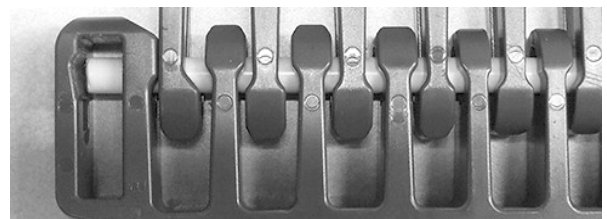

Figure 332: Ensure rod is past retention feature

REMOVE THE ROD

1. Grip the rod in the opening near the belt edge.
2. Push the rod slightly to the side and past the occluded hole.

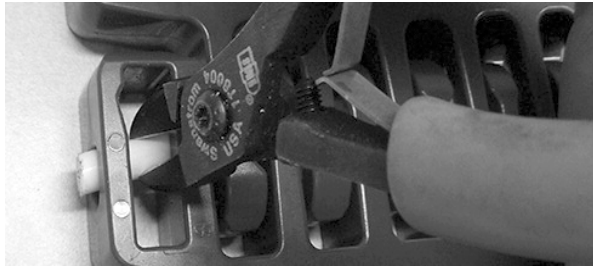

Figure 333: Push rod to side and past occluded hole

3. Once past the belt edge, pull the rod out to open the belt.

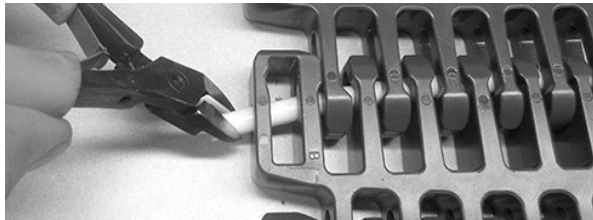

Figure 334: Pull rod from belt

SPIRAL SPROCKET INSTALLATION

1. Mount the sprockets on the primary drive shaft so they are evenly distributed, with all sprocket teeth aligned in the same direction when looking down the shaft.
2. Ensure all sprocket alignment notches are aligned down the length of the shaft. See [Sprocket Installation](#) in [Equipment Installation Overview](#).
3. Ensure the outer edge sprockets adhere to the following minimum sprocket indents: 4.75 in (120.7 mm) indent from inner and outer belt edge.
4. Install two support rollers on the inner and outer belt edges. For 1.1 turn radius, a minimum of two support rollers are recommended to be locked down approximately 2 in (50.8 mm) and 6 in (152.4 mm) from the inside edge.

5. Secure both sides of all sprockets using the stainless steel split collar retainer rings.



Figure 335: Secure both sides of all sprockets

6. Ensure the sprockets properly engage the belt and allow belting to find its natural path.

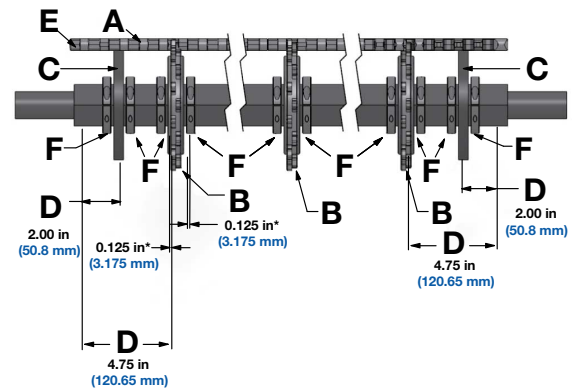

- A Belt
- B Sprocket
- C Support wheel
- D Sprocket indent
- E Inside edge of belt
- F Split heavy-duty retainer ring
- * Typical

NOTE: All sprockets and support wheels require split heavy-duty retainer rings.

Figure 336: Ensure sprockets properly engage belt

SERIES 2800-1

BELTS COVERED IN SECTION

- SpiralDirectDrive™
- Spiral GTech 1.6 Radius
- Spiral GTech 2.2 and 3.2
- Spiral GTech Rounded Friction Top



This belt can trap and injure fingers. Never touch a moving belt! Stop the conveyor before servicing.

NOTE: Before use in food-safe applications, follow good manufacturing practice and thoroughly clean and sanitize belts according to your standard sanitary operating procedures.

UNHEADED ROD

INSERT THE ROD

NOTE: S2800 requires all rod insertion to occur on the outside belt edge.

1. Ensure the rods are 0.240 in (6 mm) diameter unheaded rods.
2. Cut rods 0.6 in (15.2 mm) shorter than the overall belt width.
3. Join belt ends together so the hinges are aligned.
4. Insert the rod through the hinges as far as possible.

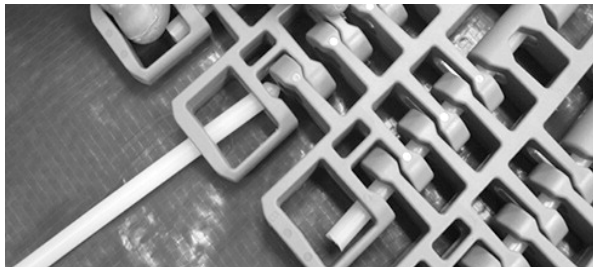

Figure 337: Insert rod through hinges

5. Use a screwdriver to push the rod past the retention feature.



Figure 338: Push rod past retention feature

6. Ensure the rod is fully inserted.

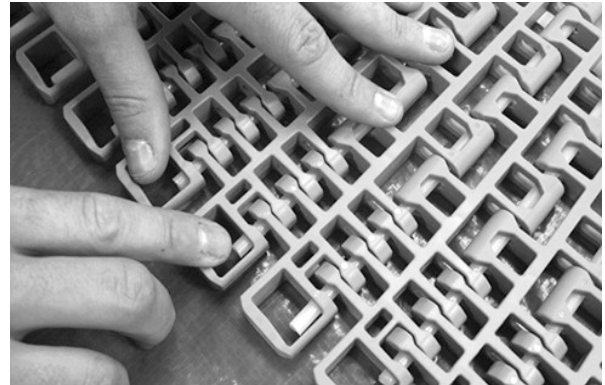

Figure 339: Ensure rod is past retention feature

REMOVE THE ROD

NOTE: S2800 requires all rod removal to occur on the outside belt edge.

1. On the bottom of the belt, grip the rod in the opening near the belt edge.
2. Push the rod slightly to the side and past the retention feature.
3. Once past the belt edge, pull the rod out to open the belt.



Figure 340: Pull rod from belt

SPIRAL SPROCKET INSTALLATION

S2800 SPIRAL GTECH 1.6, 2.2, 3.2

- All sprockets and support wheels require split heavy-duty retainer rings.
- 0.125 in (3 mm) clearance must be maintained between the retainer rings and the sprockets/support wheels.
- Sprockets must be installed so that the teeth drive the hinge of the belt.

SERIES 2800-1

- Outermost sprocket installation location depends on the orientation of the outermost module.

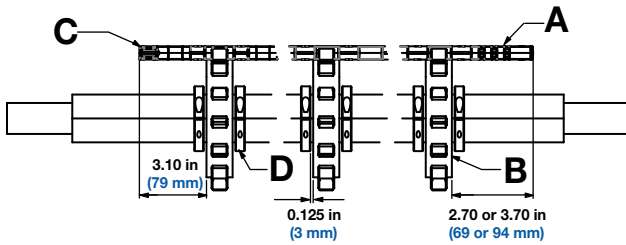

- A Belt
- B Sprocket
- C Inside edge of belt
- D Split heavy-duty retainer ring

Figure 341: Belt width of 24 in (610 mm) and less

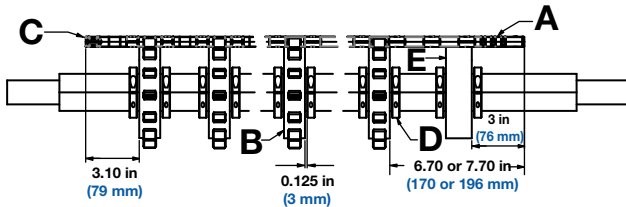

- A Belt
- B Sprocket
- C Inside edge of belt
- D Split heavy-duty retainer ring
- E Support wheel

Figure 342: Belt width of 16 in (407 mm) to 24 in (610 mm)

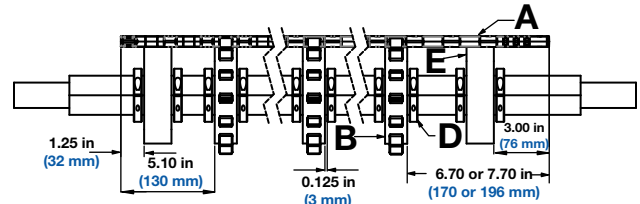

- A Belt
- B Sprocket
- C Inside edge of belt
- D Split heavy-duty retainer ring
- E Support wheel

Figure 343: Belt width of 24 in (610 mm) and more

S2800 SPIRAL DIRECTDRIVE-HOLES LEADING

- All sprockets and support wheels require split heavy-duty retainer rings.
- 0.125 in (3 mm) clearance must be maintained between the retainer rings and the sprockets/support wheels.
- Sprockets must be installed so that the teeth drive the hinge of the belt.

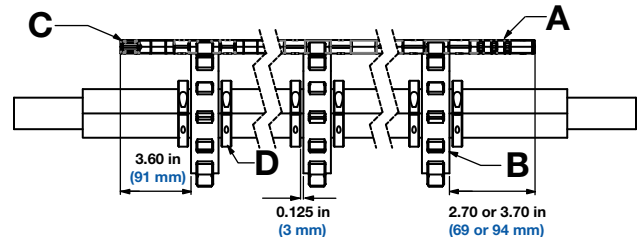

- A Belt
- B Sprocket
- C Inside edge of belt
- D Split heavy-duty retainer ring

Figure 344: Belt width of 16 in (407 mm) and less

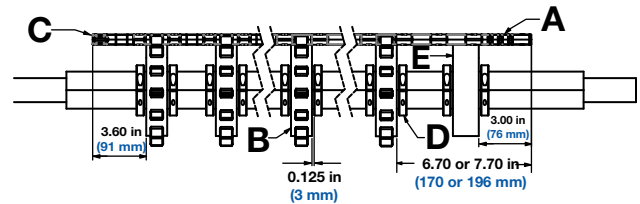

- A Belt
- B Sprocket
- C Inside edge of belt
- D Split heavy-duty retainer ring
- E Support wheel

Figure 345: Belt width of 16 in (407 mm) to 24 in (610 mm)

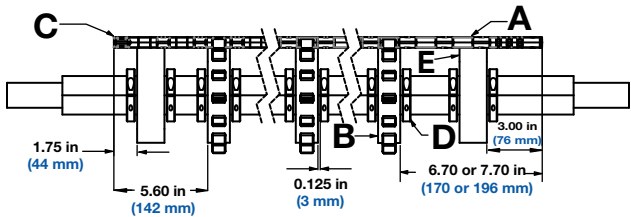

- A Belt
- B Sprocket
- C Inside edge of belt
- D Split heavy-duty retainer ring
- E Support wheel

Figure 346: Belt width of 24 in (610 mm) and more

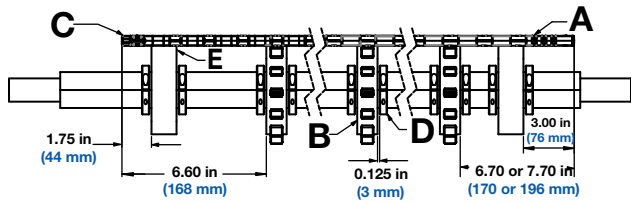

- A Belt
- B Sprocket
- C Inside edge of belt
- D Split heavy-duty retainer ring
- E Support wheel

Figure 349: Belt width of 24 in (610 mm) and more

S2800 SPIRAL DIRECTDRIVE—SLOTS LEADING

- All sprockets and support wheels require split heavy-duty retainer rings.
- 0.125 in (3 mm) clearance must be maintained between the retainer rings and the sprockets/support wheels.
- Sprockets must be installed so that the teeth drive the hinge of the belt.

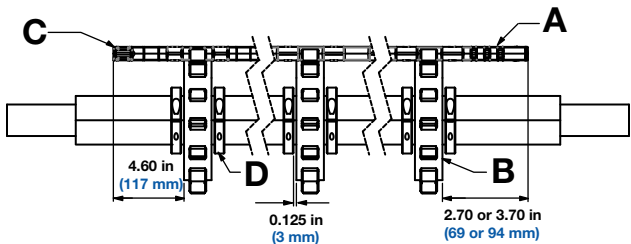

- A Belt
- B Sprocket
- C Inside edge of belt
- D Split heavy-duty retainer ring

Figure 347: Belt width of 16 in (407 mm) and less

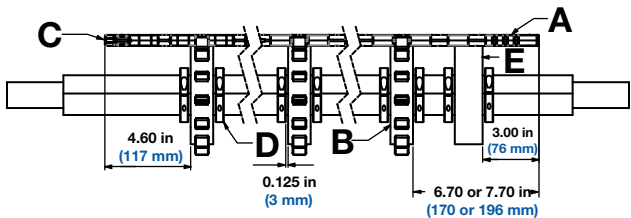

- A Belt
- B Sprocket
- C Inside edge of belt
- D Split heavy-duty retainer ring
- E Support wheel

Figure 348: Belt width of 16 in (407 mm) to 24 in (610 mm)

SERIES 2850-1

BELTS COVERED IN SECTION

- DirectDrive™ Stacker



This belt can trap and injure fingers. Never touch a moving belt! Stop the conveyor before servicing.

NOTE: Before use in food-safe applications, follow good manufacturing practice and thoroughly clean and sanitize belts according to your standard sanitary operating procedures.

UNHEADED ROD

INSERT THE ROD

NOTE: S2850 requires all rod insertion to occur on the outside belt edge.

1. Ensure the rods are 0.240 in (6 mm) diameter unheaded rods.
2. Cut rods 0.6 in (15.2 mm) shorter than the overall belt width.
3. Join belt ends together so the hinges are aligned.
4. Insert the rod through the hinges as far as possible.

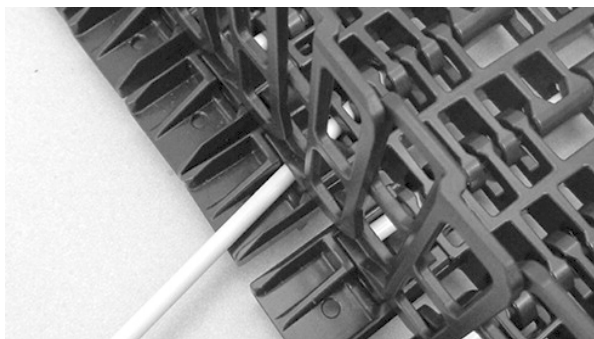

Figure 350: Insert rod through hinges

5. Use a screwdriver to push the rod past the retention feature.

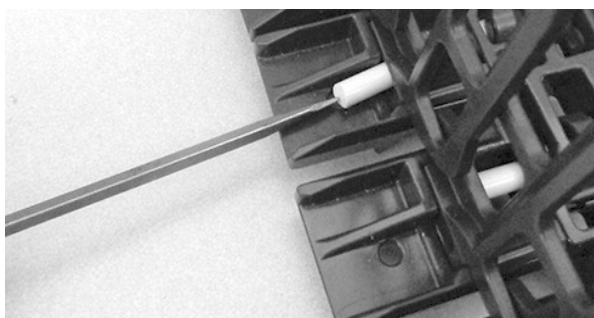

Figure 351: Push rod past retention feature

6. Ensure the rod is fully inserted.

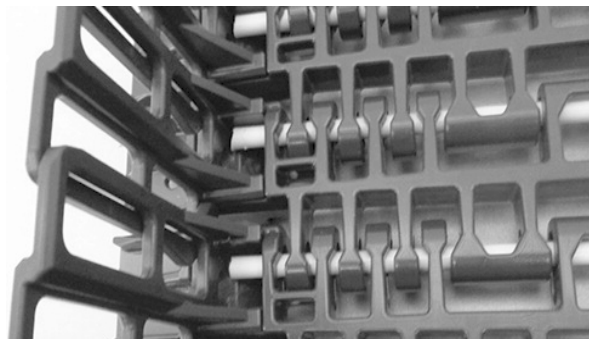

Figure 352: Ensure rod is past retention feature

REMOVE THE ROD

NOTE: S2850 requires all rod removal to occur on the outside belt edge.

1. On the bottom of the belt, grip the rod in the opening near the belt edge.
2. Push the rod slightly to the side and past the retention feature.
3. Once past the belt edge, pull the rod out to open the belt.



Figure 353: Pull rod from belt

SERIES 2900-1

BELTS COVERED IN SECTION

- Spiral DirectDrive™
- Spiral 1.6 and 2.2



This belt can trap and injure fingers. Never touch a moving belt! Stop the conveyor before servicing.

NOTE: Before use in food-safe applications, follow good manufacturing practice and thoroughly clean and sanitize belts according to your standard sanitary operating procedures.

UNHEADED ROD

INSERT THE ROD

NOTE: S2900 requires all rod insertion to occur on the outside belt edge.

1. Ensure the rods are 0.240 in (6 mm) diameter unheaded rods.
2. Cut rods 0.95 in (24.1 mm) shorter than the overall belt width.
3. Join belt ends together so the hinges are aligned.
4. Insert the rod through the hinges as far as possible.

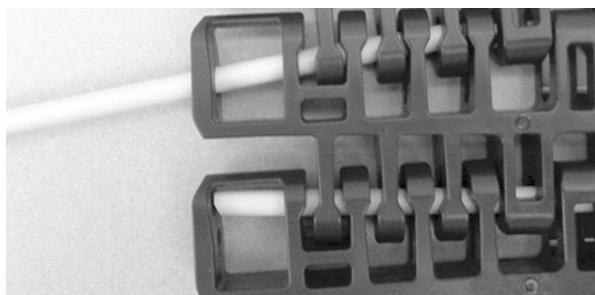

Figure 354: Insert rod through hinges

5. Use a screwdriver to push the rod past the retention feature.

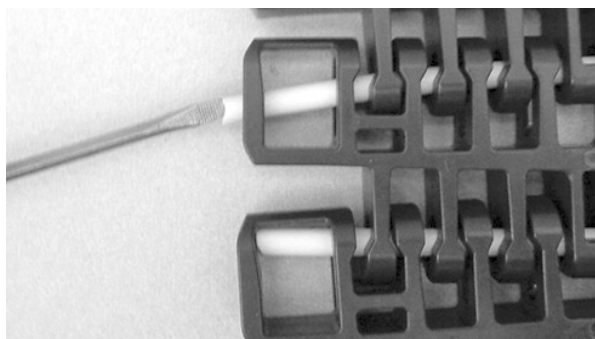

Figure 355: Push rod past retention feature

6. Ensure the rod is fully inserted.

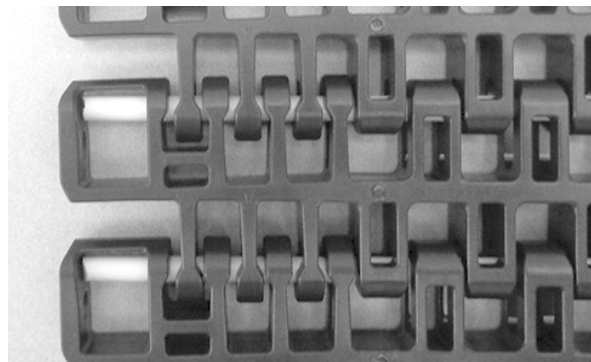

Figure 356: Ensure rod is past retention feature

REMOVE THE ROD

NOTE: S2900 requires all rod removal to occur on the outside belt edge.

1. On the bottom of the belt, grip the rod in the opening near the belt edge.
2. Push the rod slightly to the side and past the retention feature.
3. Once past the belt edge, pull the rod out to open the belt.

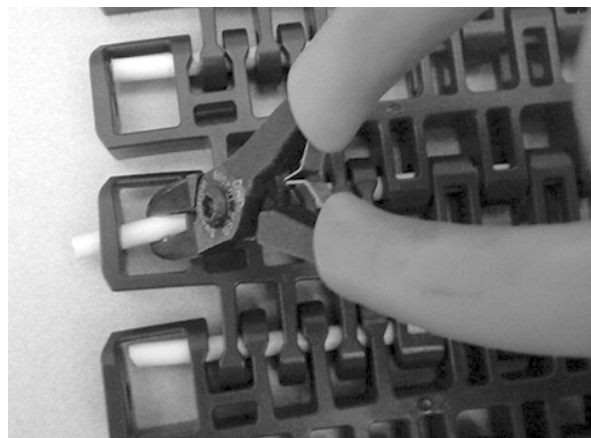

Figure 357: Push rod past retention feature

S2900 SPIRAL DIRECTDRIVE

- All sprockets and support wheels require split heavy-duty retainer rings.
- 0.125 in (3 mm) clearance must be maintained between the retainer rings and the sprockets/support wheels.

SERIES 2900-1

- Sprockets must be installed so that the teeth drive the hinge of the belt.

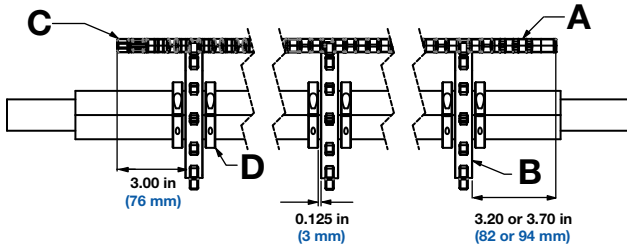

- A Belt
- B Sprocket
- C Inside edge of belt
- D Split heavy-duty retainer ring

Figure 358: Belt width of 16 in (407 mm) and less

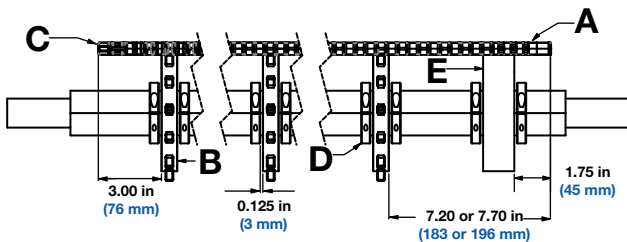

- A Belt
- B Sprocket
- C Inside edge of belt
- D Split heavy-duty retainer ring
- E Support wheel

Figure 359: Belt width of 16 in (407 mm) to 24 in (610 mm)

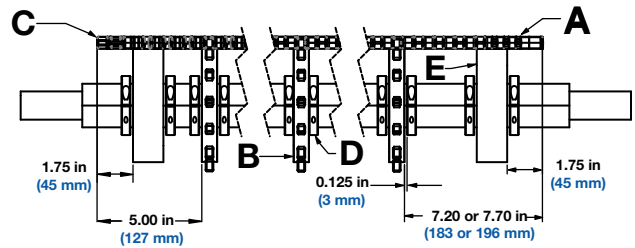

- A Belt
- B Sprocket
- C Inside edge of belt
- D Split heavy-duty retainer ring
- E Support wheel

Figure 360: Belt width of 24 in (610 mm) and more

S2900 SPIRAL GTECH 1.6 AND 2.2

- All sprockets and support wheels require split heavy-duty retainer rings.
- 0.125 in (3 mm) clearance must be maintained between the retainer rings and the sprockets/support wheels.
- Sprockets must be installed so that the teeth drive the hinge of the belt

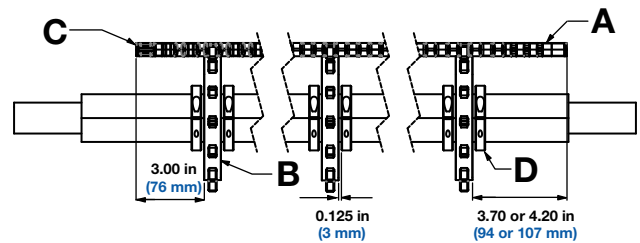

- A Belt
- B Sprocket
- C Inside edge of belt
- D Split heavy-duty retainer ring

Figure 361: Belt width of 16 in (407 mm) and less

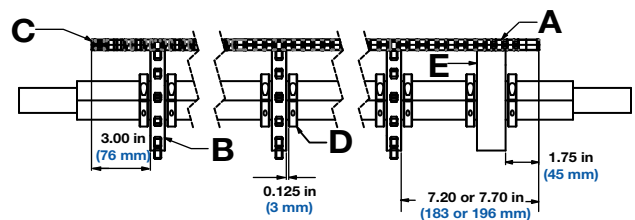

- A Belt
- B Sprocket
- C Inside edge of belt
- D Split heavy-duty retainer ring
- E Support wheel

Figure 362: Belt width of 16 in (407 mm) to 24 in (610 mm)

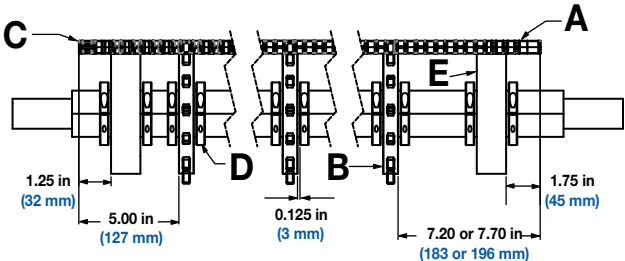

- A Belt
- B Sprocket
- C Inside edge of belt
- D Split heavy-duty retainer ring
- E Support wheel

Figure 363: Belt width of 24 in (610 mm) and more

SERIES 2950-1

BELTS COVERED IN SECTION

- DirectDrive™ Stacker



This belt can trap and injure fingers. Never touch a moving belt! Stop the conveyor before servicing.

NOTE: Before use in food-safe applications, follow good manufacturing practice and thoroughly clean and sanitize belts according to your standard sanitary operating procedures.

UNHEADED ROD

INSERT THE ROD

NOTE: S2950 requires all rod insertion to occur on the outside belt edge.

1. Ensure the rods are 0.240 in (6 mm) diameter unheaded rods.
2. Cut rods 0.95 in (24.1 mm) shorter than the overall belt width.
3. Join belt ends together so the hinges are aligned.
4. Insert the rod through the hinges as far as possible.

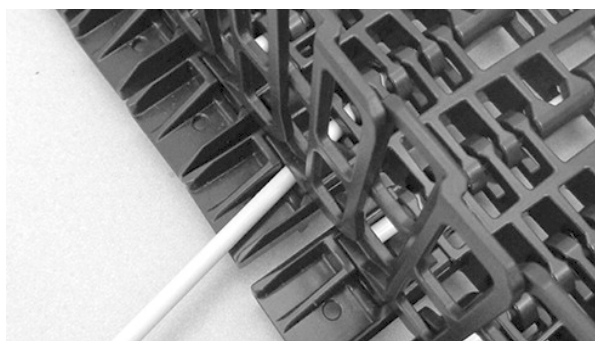

Figure 364: Insert rod through hinges

5. Use a screwdriver to push the rod past the retention feature.

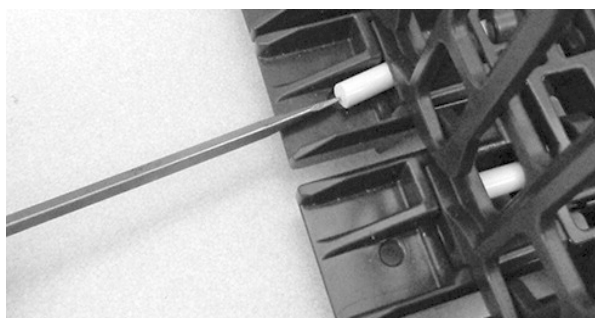

Figure 365: Push rod past retention feature

6. Ensure the rod is fully inserted.

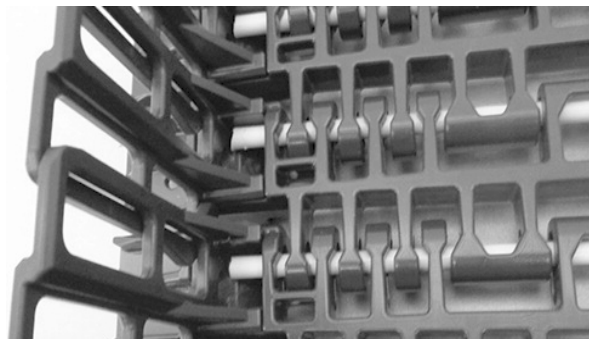

Figure 366: Ensure rod is past retention feature

REMOVE THE ROD

NOTE: S2950 requires all rod removal to occur on the outside belt edge.

1. On the bottom of the belt, grip the rod in the opening near the belt edge.
2. Push the rod slightly to the side and past the retention feature.
3. Once past the belt edge, pull the rod out to open the belt.



Figure 367: Push rod past retention feature

BELTING STORAGE RECOMMENDATIONS

The following information provides some basic suggestions to ensure your Intralox belting remains in good condition and avoids possible damage when stored. For wider, nylon belts, Intralox suggests keeping a complete spare belt in inventory to minimize downtime in an emergency.

NOTE: Contact Intralox Customer Service if you have any questions about proper belt storage.

STORAGE SUGGESTIONS

Store in climate-controlled environment: If possible, store belting in a climate-controlled environment to minimize damage from excessive heat and moisture.

Keep belting boxed: If possible, store belting in original packaging to minimize damage from direct light, dust and debris buildup, and excessive movement.

STORAGE WARNINGS

Avoid storing belts in stacks: If possible, avoid storing belts in stacks to minimize hinge stress.

Do NOT stack belts with accessories: Do not store belts with flights or other accessories flat or in stacked layers to avoid stress and warping.

Do NOT stack heavy belts: Do not store belts heavier than 100 lb (45 kg) in stacked layers to avoid stress, deflection, and warping.

Separate stacked belts with cardboard: If belts weighing less than 100 lb (45 kg) are stacked, place cardboard between each belt layer to minimize damage to belt edges.

BELT MATERIAL GROWTH

Belt materials, especially nylon, can expand or contract depending on storage and use conditions. In high-temperature and high-humidity environments, belts can expand over time. In cooler, drier conditions, belts can contract. Intralox provides belt widths and tolerances that account for potential expansion and contraction during the belt assembly process. Operating conditions are not

accounted for. Once a belt leaves our assembly facility, environmental conditions can cause the belt width to change. Contact Intralox Customer Service for more information.

REPLACEMENT BELTS

When ordering replacement belts, accurate belt width and link count are important. Intralox can help determine this information. Contact Intralox Customer Service for more information.

Allow the belt sections to acclimate to the operating environment for about two days before installation. If a delay is not possible, or there is splicing difficulty, contact Intralox Customer Service.

PREVENTIVE MAINTENANCE

Perform the following procedures at the frequency indicated to maintain the Intralox belting system. Initially, performing this inspection on a monthly basis enables you to spot any wear trends and develop a feel for the operational characteristics of the conveyor.

Repair or replace any damaged components and repair any faulty processes.

Contact Intralox (the nearest Intralox office or Customer Service Representative) regarding any problems not explained here.

Tech. Initials	Maintenance Procedure to Perform	Monthly Interval			
		1	3	6	12
	General/Safety Inspection				
	Inspect the belt for missing or damaged belt modules. Repair or replace parts as needed.	x			
	Inspect sprockets for mistracking or movement on the shaft. Repair or replace parts as needed to prevent premature belt and sprocket wear.	x			
	Inspect the conveyor for missing or damaged return rollers, shoes, and wearstrips. Repair or replace parts as needed to prevent premature belt and sprocket wear.	x			
	Inspect the belt for missing, damaged, or protruding belt rods. Repair or replace parts as needed.	x			
	Inspect all incoming power sources to the equipment (air hoses, fittings, connections) for good working condition. Repair or replace parts as needed.	x			
	Secure any misaligned or loose components, fasteners, etc. Repair or replace parts as needed.	x			

TROUBLESHOOTING

This guide is designed to help diagnose and resolve mechanical problems on conveyors using an Intralox belting system. If you require further help, contact the nearest Intralox office listed on the back cover.

STRAIGHT-RUNNING BELTS

Problem	Possible Cause	Solution
Belt not engaging drive sprockets	Incorrect belt tension around drive sprockets	<ol style="list-style-type: none"> 1. Ensure the belt returnway allows recommended catenary sag. 2. Respace rollers to get proper sag and bypass the slider bed returnway to get proper sag. 3. Contact Intralox Customer Service for further assistance.
	Incorrect A or B dimension	Compare existing shaft location to that recommended for A and B conveyor frame dimensions in the Intralox Engineering Manual. Adjust the drive shaft as necessary to meet these dimensions.
	Incorrect belt returnway design	<ol style="list-style-type: none"> 1. Ensure the belt returnway provides recommended catenary sag. 2. Respace rollers to get proper sag and bypass the slider bed returnway to get proper sag. 3. Contact Intralox Customer Service for further assistance.
	Sprockets not aligned correctly on shafts	Ensure sprockets are timed identically and all sprocket teeth line up when looking down the shaft. See Sprocket Installation for more information.
	Insufficient belt wrap around drive sprockets	Move the return roller nearest the drive shaft so at least 180 degrees of the belt wraps around the drive sprockets. Contact Intralox Customer Service for further assistance.
Belt not tracking properly	Drive and idle shafts not plumb, level, and square	<ol style="list-style-type: none"> 1. Adjust shafts to be plumb, level, and square. 2. Ensure sprockets are held in place with shaft collars.
	Conveyor frame and/or components not level or square	<ol style="list-style-type: none"> 1. Square and level the conveyor frame. 2. Check shaft alignment after adjusting the frame. 3. Replumb, level, and square the shafts if needed.
	Return rollers not level and square to conveyor frame	Adjust return rollers to be level or square with conveyor frame.
	Sprockets not aligned correctly on shafts	Ensure sprockets are timed identically and all sprocket teeth line up when looking down the shaft. See Sprocket Installation for more information.
	Locked sprockets on drive and idle shafts are not properly aligned	<ol style="list-style-type: none"> 1. Realign the locked sprockets. 2. Ensure the drive shaft sprocket is aligned with the idle shaft sprocket. See Sprocket Installation for more information.
	Material build-up on bottom of belt interfering with proper sprocket tooth engagement	Clean the bottom of the belt to remove any debris that could interfere with sprocket tooth engagement. Consider installing in-place brushes, scrapers, scrolls, or other devices to prevent future buildup.
	Belt improperly installed	With the exception of Series 200, all belt edges should be flush when spliced properly. See belt series and style instructions for specific splicing instructions.
	Retainer rings improperly installed or missing	<ol style="list-style-type: none"> 1. Install the retainer rings so the locked sprockets on the drive and idle shafts are aligned. 2. Replace any missing retainer rings.
Excessive belt wear	Belts, sprockets, or wearstrip exposed to abrasive material	<ul style="list-style-type: none"> • Eliminate or reduce belt, sprocket, and wearstrip exposure to abrasive material. • Use pressurized air to blow debris from equipment or wash off equipment regularly.

TROUBLESHOOTING

Problem	Possible Cause	Solution
	Incorrect wearstrip material	To ensure wearstrip material is correct for the application, contact Intralox for assistance in wearstrip selection.
	Binding of belt in conveyor frame	<ol style="list-style-type: none"> 1. Square and level the conveyor frame. 2. Remove any obstructions causing the belt to rub or bind.
	Uneven or incorrect product loading	<ul style="list-style-type: none"> • Add support under belt loading area. • Consider adding a chute to orient conveyed material so it travels in the same direction as the belt and at a similar speed. • Consider adding a side guide to the opposite side of the belt for side-loaded conveyors. <p>Contact Intralox Customer Service for more information.</p>
	Excessive belt speed	Reduce belt speed if possible. High-speed belts, especially those with short shaft centers, wear faster than belts at lower speeds.
	Incorrect wearstrip spacing	Contact Intralox Customer Service for more information. Wearstrip spacing varies with the load on the belt, belt style, and temperature.
	Sharp corners on carryway or returnway wearstrips	Bevel or radius the leading edge of carryway and returnway wearstrips and slider beds for smooth belt travel.
	Excessive sprocket wear	Sprockets exposed to abrasive material
Incorrect tension on belt		<ol style="list-style-type: none"> 1. Ensure the belt is properly tensioned around the drive sprockets. 2. Ensure the belt returnway allows recommended catenary sag. 3. Respace rollers to get proper sag and bypass the slider bed returnway to get proper sag. 4. Contact Intralox Customer Service for further assistance.
Excessive belt speed		Reduce belt speed if possible. High-speed belts, especially those with short shaft centers, wear faster than belts at lower speeds.
Drive and idle shafts not plumb, level, and square		<ul style="list-style-type: none"> • Adjust shafts to be plumb, level, and square. • Ensure sprockets are held in place with shaft collars.
Insufficient number of sprockets		The conveyor may require a more even load distribution among sprockets. Contact Intralox Customer Service for more information.
Locked sprockets on drive and idle shafts are not properly aligned		<ol style="list-style-type: none"> 1. Realign the locked sprockets. 2. Ensure the drive shaft sprocket is aligned with the idle shaft sprocket. <p>See Sprocket Installation for more information.</p>
Sprockets not aligned correctly on shafts		Ensure sprockets are timed identically and all sprocket teeth line up when looking down the shaft. See Sprocket Installation for more information.
Incorrect A or B dimension		Compare existing shaft location to that recommended for A and B conveyor frame dimensions in the Intralox Engineering Manual. Adjust the drive shaft as necessary to meet these dimensions.
Shaft deflection or twisting		<ol style="list-style-type: none"> 1. Inspect shaft for deflection or twisting. 2. Replace any bent or twisted shafts. <p>Wide belts may require an intermediate bearing. Contact Intralox Customer Service for more information.</p>
Excessive belt edge wear or damage	Belt contacting obstructions on conveyor frame, returnway, or adjacent equipment	<ul style="list-style-type: none"> • Square and level the conveyor frame. • Remove any obstructions causing the belt to rub or bind. • Ensure locked sprockets are secure. • Ensure sprockets are square.

TROUBLESHOOTING

Problem	Possible Cause	Solution
	Belt improperly aligned and not tracking correctly	<ul style="list-style-type: none"> • Realign the locked sprockets. • Align the drive shaft sprocket with the idle shaft sprocket. See Sprocket Installation for more information. • Square and level the conveyor frame. • Remove any obstructions causing the belt to rub or bind. • Ensure sprockets are square.
	Thermal expansion is causing belt edge to rub on conveyor frame	Ensure there is a 0.25 in (6.4 mm) minimum clearance on each side of the belt when the belt is under full thermal expansion (highest temperature).
	Conveyor frame and/or components not level or square	<ul style="list-style-type: none"> • Square and level the conveyor frame. • Remove any obstructions causing the belt to rub or bind. • Ensure locked sprockets are secure. • Ensure sprockets are square.
	Shafts not properly locked in place with shaft collars, allowing the shafts to migrate to one side	<ul style="list-style-type: none"> • Adjust shafts to be plumb, level, and square • Ensure sprockets are held in place with shaft collars.
	Belt improperly installed	With the exception of Series 200, all belt edges should be flush when spliced properly. See belt series and style instructions for specific splicing instructions.
	Belt edge not guided through a submerged application	Contact Intralox Customer Service for more information. Because Intralox belts are buoyant in most solutions, it is necessary to control the belt course to prevent edge wear.
Sprockets move laterally to center or edge of belt	Drive and idle shafts not plumb, level, and square	<ul style="list-style-type: none"> • Adjust shafts to be plumb, level, and square. • Ensure sprockets are held in place with shaft collars.
	Retainer rings improperly installed or missing	<ol style="list-style-type: none"> 1. Install the retainer rings so the locked sprockets on the drive and idle shafts are aligned. 2. Replace any missing retainer rings.
	Locked sprockets on drive and idle shafts are not properly aligned	<ol style="list-style-type: none"> 1. Realign the locked sprockets. 2. Ensure the drive shaft sprocket is aligned with the idle shaft sprocket. See Sprocket Installation for more information.
	Sprockets not aligned correctly on shafts	Ensure sprockets are timed identically and all sprocket teeth line up when looking down the shaft. See Sprocket Installation for more information.
	Material buildup on bottom of belt preventing proper tooth engagement	Clean the bottom of the belt to remove any debris that could interfere with sprocket tooth engagement. Consider installing in-place brushes, scrapers, scrolls, or other devices to prevent future buildup.
	Belt improperly installed	With the exception of Series 200, all belt edges should be flush when spliced properly. See belt series and style instructions for specific splicing instructions.
	Shaft deflection or twisting	<ol style="list-style-type: none"> 1. Inspect shaft for deflection or twisting. 2. Replace any bent or twisted shafts. <p>Wide belts may require an intermediate bearing. Contact Intralox Customer Service for more information.</p>
Belt rod pushing out of belt	Rods not properly installed	See belt series and style instructions for specific splicing instructions.
	Drive and idle shafts not plumb, level, and square	<ul style="list-style-type: none"> • Adjust shafts to be plumb, level, and square. • Ensure sprockets are held in place with shaft collars.
Sideguard wear or damage (including breakage)	Sideguards contacting obstructions on conveyor frame, returnway, or adjacent equipment.	<ul style="list-style-type: none"> • Remove sideguard travel obstructions. • Square and level the conveyor frame. • Remove any obstructions causing the belt to rub or bind. • Secure locked sprockets. • Ensure sprockets are square.

TROUBLESHOOTING

Problem	Possible Cause	Solution
	Uneven or incorrect product loading	<ul style="list-style-type: none"> • Add support under belt loading area. • Consider adding a chute to orient conveyed material so it travels in the same direction as the belt and at a similar speed. • Consider adding a side guide to the opposite side of the belt for side-loaded conveyors. Contact Intralox Customer Service for more information.
Flight wear or damage	Flights contacting obstructions on conveyor frame, returnway, or adjacent equipment	<ul style="list-style-type: none"> • Remove debris blocking the flight travel. • Square and level the conveyor frame. • Remove any obstructions causing the belt to rub or bind. • Secure locked sprockets. • Ensure sprockets are square.
	Uneven or incorrect product loading	<ul style="list-style-type: none"> • Add support under belt loading area. • Consider adding a chute to orient conveyed material so it travels in the same direction as the belt and at a similar speed. • Consider adding a side guide to the opposite side of the belt for side-loaded conveyors. Contact Intralox Customer Service for more information.
	High impact in infeed area	Add an impact plate or chute above the belt to absorb initial shock and reduce or eliminate belt impact. Mount the impact plate at an angle so product travels gently onto the belt.
	Improper flight support on returnway	Ensure return rails support flighted belts on both sides of the belt along the returnway and as needed across the belt width. Contact Intralox Customer Service for more information.
Impact damage to belt	Uneven or incorrect product loading	<ul style="list-style-type: none"> • Add support under belt loading area. • Consider adding a chute to orient conveyed material so it travels in the same direction as the belt and at a similar speed. • Consider adding a side guide to the opposite side of the belt for side-loaded conveyors. Contact Intralox Customer Service for more information.
	Unsuitable belt material	Ensure belt material is appropriate for application. See Belt Selection Process in the Intralox Modular Plastic Conveyor Belts Engineering Manual or contact Intralox Customer Service for assistance.
	Application is outside the performance range of a plastic conveyor belt	Contact Intralox Customer Service for more information.
Finger transfer plate damage	Incorrect finger transfer plate mounting	<ul style="list-style-type: none"> • Ensure finger transfer plates are not tightened down too firmly on the mounting support surface. • Ensure the finger transfer plates are mounted straight, level, and not bent or twisted. • See the Design Guidelines in the Intralox Modular Plastic Conveyor Belts Engineering Manual for correct dimensional information and installation information.
	Excessive heat at finger transfer plate area	If belts in a high heat area expand beyond the range allowed by the slotted holes on the finger transfer plates, contact Intralox Customer Service for assistance.
	Raised Rib belt not tracking properly	Correct belt tracking. See Troubleshooting .
	Material buildup between Raised Ribs	<ul style="list-style-type: none"> • If possible, eliminate the source of the material buildup. • Routinely inspect and clean any unpreventable debris from the belt.
	Incorrect A or B dimensions	Compare existing shaft location to that recommended for A and B conveyor frame dimensions in the Intralox Engineering Manual. Adjust the drive shaft as necessary to meet these dimensions.

TROUBLESHOOTING

Problem	Possible Cause	Solution
	Shaft deflection or twisting	<ol style="list-style-type: none"> 1. Inspect shaft for deflection or twisting. 2. Replace any bent or twisted shafts. Wide belts may require an intermediate bearing. Contact Intralox Customer Service for more information.
	Sprockets not aligned correctly on shafts	Ensure sprockets are timed identically and all sprocket teeth line up when looking down the shaft. See Sprocket Installation for more information.
Belt develops excessive catenary sag	Incorrect total belt length	<ul style="list-style-type: none"> • Inspect catenary sag at the belt's coldest operating temperature. • If needed, remove rows of modules to shorten the belt and remove excess catenary sag. <p>NOTE: Some belts can only be shortened in two-row increments.</p>
	Insufficient belt tension in high heat applications	If the excess catenary sag is due to thermal expansion from operational temperatures and is not excessive when cold, adding a take-up/tensioning device on the conveyor to compensate for the thermal growth may be necessary. Contact Intralox Customer Service for more information.
	Elongation of belt due to initial startup situation or heavy loads	<ul style="list-style-type: none"> • Belts elongate during the initial break-in period. This is a natural part of the belt adjusting to the application and is more noticeable with heavy loads. • Allow the belt to adjust to operating conditions before shortening. • Monitor the belt during this break-in to avoid binding or catching.

RADIUS BELTS

Problem	Possible Causes	Solutions
Belt not engaging with drive sprockets	Incorrect belt tension around drive sprockets	Series 2200 and Series 2400 require little tension, but belt length changes and the dynamics of the returnway can cause the belt to skip off the sprockets. A snub roller is recommended to keep the belt wrapped at least 180° around the sprocket.
	Adjustments are needed o belt length due to changes in temperature, load, or wear	If excess belt slack after the drive sprockets causes the belt to bounce off the drive sprockets, installing a snub roller may prevent this. A vertical belt take-up before the first turn may also be needed.
Belt not engaging with drive sprockets	The straight section of belt from curve to drive shaft is less than 1.5 times the belt width. This difference causes the belt to have different pitches at the two belt edges, which results in the belt walking to the outside of the last curve.	Ensure the straight section is at least 1.5 times the belt width.
	Unsupported belt edge leading to the drive sprockets	Install a guide rail on the outside edge of the belt leading to the drive shaft to prevent the belt from walking toward the outside of the last turn.
	Returnway section not vertically parallel with carryway section, which forces the sprocket rotation to be out of line with the belt travel.	Ensure both the carryway and returnway are vertically parallel.
	Locked sprockets and hold down guides are over-constraining the belt.	Ensure only one method of tracking is used—either locked sprockets or hold down guides. NOTE: DO NOT use a hold down AND locked sprockets on Series 2200 or 2400 belts.

TROUBLESHOOTING

Problem	Possible Causes	Solutions
Excessive wear on the guide rail wearstrip, especially in turns.	PV value of guide rail wearstrip material is exceeded.	<ol style="list-style-type: none"> 1. Check the temperature of the guide rail wearstrip in the transition between straight and turning sections. A sharp rise in temperature indicates the wearstrip material is insufficient for the application. 2. Install guide rail wearstrips with a higher PV. <p>NOTE: Eventually, the guide rail wearstrip stops wearing and the belt edge begins to wear. It is better to replace wearstrips than belts.</p>
	Not enough belt clearance through the section. If the belt is bound through a section, additional compressive and tensile loads are applied to the wearstrip.	<ul style="list-style-type: none"> • Before belt installation, manually pass a piece of belt through all sections and wearstrips to ensure adequate clearance. • Ensure Intralox recommended clearance is maintained. <p>Contact Intralox Customer Service for more information.</p>
	Wearstrips in the turn not smooth or even	<ol style="list-style-type: none"> 1. Check the temperature of the guide rail wearstrip in the turn. A higher temperature on these wearstrips indicates the wearstrip is not smooth. 2. Replace damaged, worn, or incompatible wearstrips as needed. 3. Ensure all wearstrips form a smooth arc for any turn.
Excessive sprocket wear	Unsupported belt edge leading to the drive sprockets.	Install a guide rail on the outside edge of the belt leading to the drive shaft to prevent the belt from walking toward the outside of the last turn.
	Returnway section not vertically parallel with carryway section, which forces the sprocket rotation to be out of line with the belt travel.	Ensure both the carryway and returnway are vertically parallel.
	Locked sprockets and hold down guides are over-constraining the belt.	<p>Ensure only one method of tracking is used—either locked sprockets or hold down guides.</p> <p>NOTE: DO NOT use a hold down AND locked sprockets on Series 2200 or 2400 belts.</p>
Excessive belt edge wear or damage	A catch point on the guide rail wearstrips or hold down wearstrip is snagging an edge.	<ul style="list-style-type: none"> • Remove any catch points and sharp leading edges from all guide rail wearstrips. • Ensure there is clearance between the outer hold down wearstrips and the belt when the belt is at maximum operating temperature. • Ensure outer hold down wearstrips do not catch the belt.
	Inappropriate guide rail wearstrip material.	<ul style="list-style-type: none"> • Check the guide rail wearstrip for wear. Wearstrips with little wear may have too high a PV value for the belt. • Replace any acetal, nylon, PTFE, etc. wearstrips with a plain or lubricated UHMW wearstrip. <p>NOTE: Eventually, the guide rail wearstrip stops wearing and the belt edge begins to wear. It is better to replace wearstrips than belts.</p>
Belt rod moving out of belt	Rods not correctly installed.	Reinstall the rod. See belt series and style instructions for specific splicing instructions.
Belt rod moving out of belt.	A snag or wear damaged the rod.	<ul style="list-style-type: none"> • Inspect the belt for signs of damage. • Replace any damaged belt edge modules or rods. • Repair any snags on the conveyor frame.
	If Series 2200 or Series 2400 belt, the rod tip has a sharp angle.	Always use a blunt cut on rods. An angled cut can cause the rod tip to move past the retention feature.

INDEX

B

Belt Material Growth
171

CONTACT

Intralox, L.L.C. USA, New Orleans, LA, +1-504-733-0463, Toll Free: +1-800-535-8848

Intralox, L.L.C. Europe, Amsterdam, The Netherlands, +31-20-540-36-00, Toll Free: +800-4687-2569

Intralox Shanghai LTD., Shanghai, China, +86-21-511-8400, Toll Free: 4008-423-469

Global Assembly Center Locations: Japan • United Kingdom • Australia • Brazil • India

Country- and industry-specific toll-free phone numbers and Intralox global location information is available at www.intralox.com